

> M2

Lamp Free Smart Theater User Guide

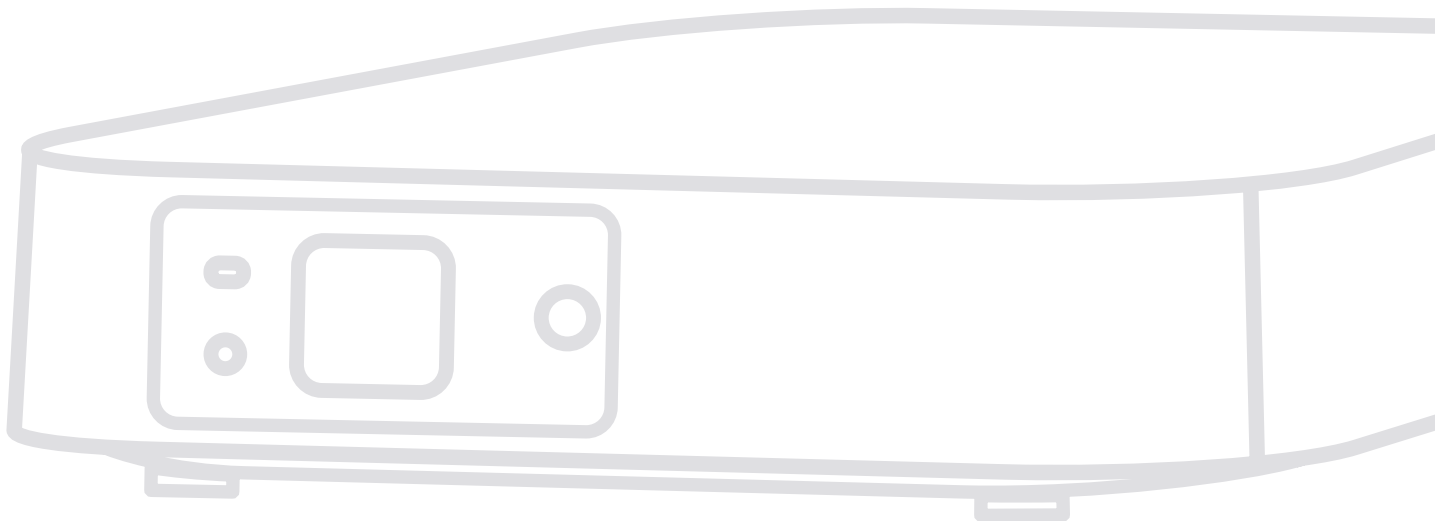

IMPORTANT: Please read this User Guide to obtain important information on installing and using your product in a safe manner, as well as registering your product for future service. Warranty information contained in this User Guide will describe your limited coverage from ViewSonic® Corporation, which is also found on our web site at <http://www.viewsonic.com> in English, or in specific languages using the Regional selection box in the upper right corner of our website. "Antes de operar su equipo lea cuidadosamente las instrucciones en este manual"

Model No. VS17808
P/N: M2

Thank you for choosing ViewSonic®

As a world-leading provider of visual solutions, ViewSonic® is dedicated to exceeding the world's expectations for technological evolution, innovation, and simplicity. At ViewSonic®, we believe that our products have the potential to make a positive impact in the world, and we are confident that the ViewSonic® product you have chosen will serve you well.

Once again, thank you for choosing ViewSonic®!

> Safety Precautions

Please read the following **Safety Precautions** before you start using the projector.

- Keep this user guide in a safe place for later reference.
- Read all warnings and follow all instructions.
- Allow at least 20" (50 cm) clearance around the projector to ensure proper ventilation.
- Place the projector in a well-ventilated area. Do not place anything on the projector that prevents heat dissipation.
- Do not place the projector on an uneven or unstable surface. The projector may fall over, causing personal injury or projector malfunction.
- Do not use if the projector is tilted at an angle of more than 10° degrees left or right, nor at an angle of more than 15° degrees forwards or backwards.
- Do not look straight at the projector lens during operation. The intense light beam may damage your eyes.
- Do not block the projection lens with any objects when the projector is under operation as this could cause objects to become heated and deformed or even cause a fire.
- Do not attempt to disassemble the projector. There are dangerous high voltages inside which may cause death if you should come into contact with live parts.
- When moving the projector, be careful not to drop or bump the projector on anything.
- Do not place any heavy objects on the projector or connection cables.
- Do not stand the projector on end vertically. Doing so may cause the projector to fall over, causing personal injury or projector malfunction.
- Avoid exposing the projector to direct sunlight or other sources of sustained heat. Do not install near any heat sources such as radiators, heat registers, stoves, or other devices (including amplifiers) that may increase the temperature of the projector to dangerous levels.
- Do not place liquids near or on the projector. Liquids spilled into the projector may cause it to fail. If the projector does become wet, disconnect it from the power supply and call your local service center to have the projector serviced.
- When the projector is under operation, you may sense some heated air and odor from its ventilation grill. It is a normal operation and not a defect.

- Do not attempt to circumvent the safety provisions of the polarized or grounding-type plug. A polarized plug has two blades with one wider than the other. A grounding-type plug has two blades and a third grounding prong. The wide and third blade are provided for your safety. If the plug does not fit into your outlet, obtain an adapter and do not attempt to force the plug into the outlet.
- When connecting to a power outlet, DO NOT remove the grounding prong. Please ensure grounding prongs are NEVER REMOVED.
- Protect the power cord from being treaded upon or pinched, particularly at the plug, and at the point where it emerges from the projector.
- In some countries, the voltage is NOT stable. This projector is designed to operate safely within a voltage between 100 to 240 volts AC, but could fail if power cuts or surges of ± 10 volts occur. In areas where voltage may fluctuate or cut out, it is recommended that you connect your projector through a power stabilizer, surge protector, or uninterruptable power supply (UPS).
- If smoke, an abnormal noise, or a strange odor is present, immediately switch the projector off and call your dealer or ViewSonic®. It is dangerous to continue using the projector.
- Use only attachments/accessories specified by the manufacturer.
- Disconnect the power cord from the AC outlet if the projector is not being used for a long period of time.
- Refer all servicing to qualified service personnel.



CAUTION: Possibly hazardous optical radiation is emitted from this product. As with any bright light source, do not stare into the beam, RG2 IEC 62471-5:2015

> Contents

Safety Precautions.....	3
Introduction	8
Features.....	8
Package Contents	9
Product Overview	10
Projector.....	10
Connection Ports.....	11
Remote Control	12
Remote Control	13
Remote Control - Effective Range	14
Remote Control - Replacing the Batteries.....	14
Initial Setup.....	15
Choosing a Location - Projection Orientation.....	15
Projection Dimensions.....	16
Mounting the Projector	17
Making Connections	18
Connecting to Power	18
DC Power (Power Outlet)	18
USB-C Power Bank.....	19
vRemote App	20
Connecting to External Devices	21
HDMI Connection	21
USB Connection.....	22
Wireless Screen Mirroring.....	23
Connecting to Audio	24
Bluetooth	24
Voice Control.....	26
Connecting to Networks.....	30
Wi-Fi Connection.....	30
Custom SSID	31

Using the Projector.....	33
Starting Up the Projector.....	33
First Time Activation.....	33
Preferred Language.....	33
Projection Orientation	34
Network Settings.....	34
Source Input	35
Selecting an Input Source	36
Adjusting the Projected Image	37
Adjusting the Projector's Height and Projection Angle	37
Shutting Down the Projector.....	38
Input Source Selected - On-Screen Display (OSD) Tree.....	39
Operating the Projector.....	52
Home Screen	52
Home Screen - On-Screen Display (OSD) Menu Tree	53
Menu Operations	57
App Store.....	57
Apps Center.....	58
File Management	60
Setting	64
Screen Mirroring	81
Appendix.....	84
Specifications.....	84
Projector Dimensions.....	86
Timing Chart	86
HDMI Video Timing	86
HDMI PC.....	87
IR Control Table	89
Glossary	90
Troubleshooting	93
LED Indicators.....	94
Maintenance.....	95
General Precautions	95
Cleaning the Lens	95
Cleaning the Case	95
Storing the Projector	95

Regulatory and Service Information	96
Compliance Information.....	96
FCC Compliance Statement.....	96
Industry Canada Statement.....	96
CE Conformity for European Countries.....	97
Declaration of RoHS2 Compliance.....	98
Indian Restriction of Hazardous Substances	99
Product Disposal at End of Product Life	99
Copyright Information	100
Customer Service	101
Limited Warranty	102
Mexico Limited Warranty.....	105

> Introduction

Combining stunning Full HD resolution with smart streaming functionality and a portable design, the ViewSonic® M2 projector delivers a theater-like experience in any room. With a lightweight design and short throw lens, the M2 can be conveniently moved from room to room, indoors to outdoors. It features 1,200 LED lumens of brightness, and with Wi-Fi connectivity, allows users to stream content from their favorite providers.

Features

- Short throw lens design allows for a projected 80” screen size from only 2.18 meters away.
- Auto V. keystone to correct a distorted image automatically.
- Bluetooth device connection, Auto Focus, and Screen Mirroring features.
- USB-C for video transmission and power supply.
- Eye protection feature in the event objects get too close to the light source.
- 16 GB internal storage (Max. 10 GB available for user storage).
- Various Color modes for different projection purposes.
- Multi-language On-Screen Display (OSD) menus.

Package Contents

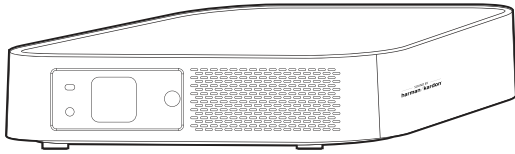

M2 Projector

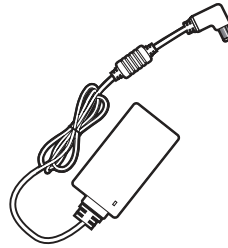

DC Power Adapter

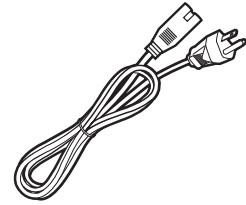

Power Cord

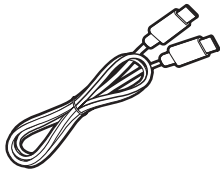

USB Type-C Cable



Batteries



Wi-Fi Dongle



Quick Start Guide

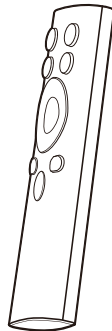

Remote Control



Soft Carrying Bag

NOTE: The power cord and video cables included in your package may vary depending on your country. Please contact your local reseller for more information.

Product Overview

Projector

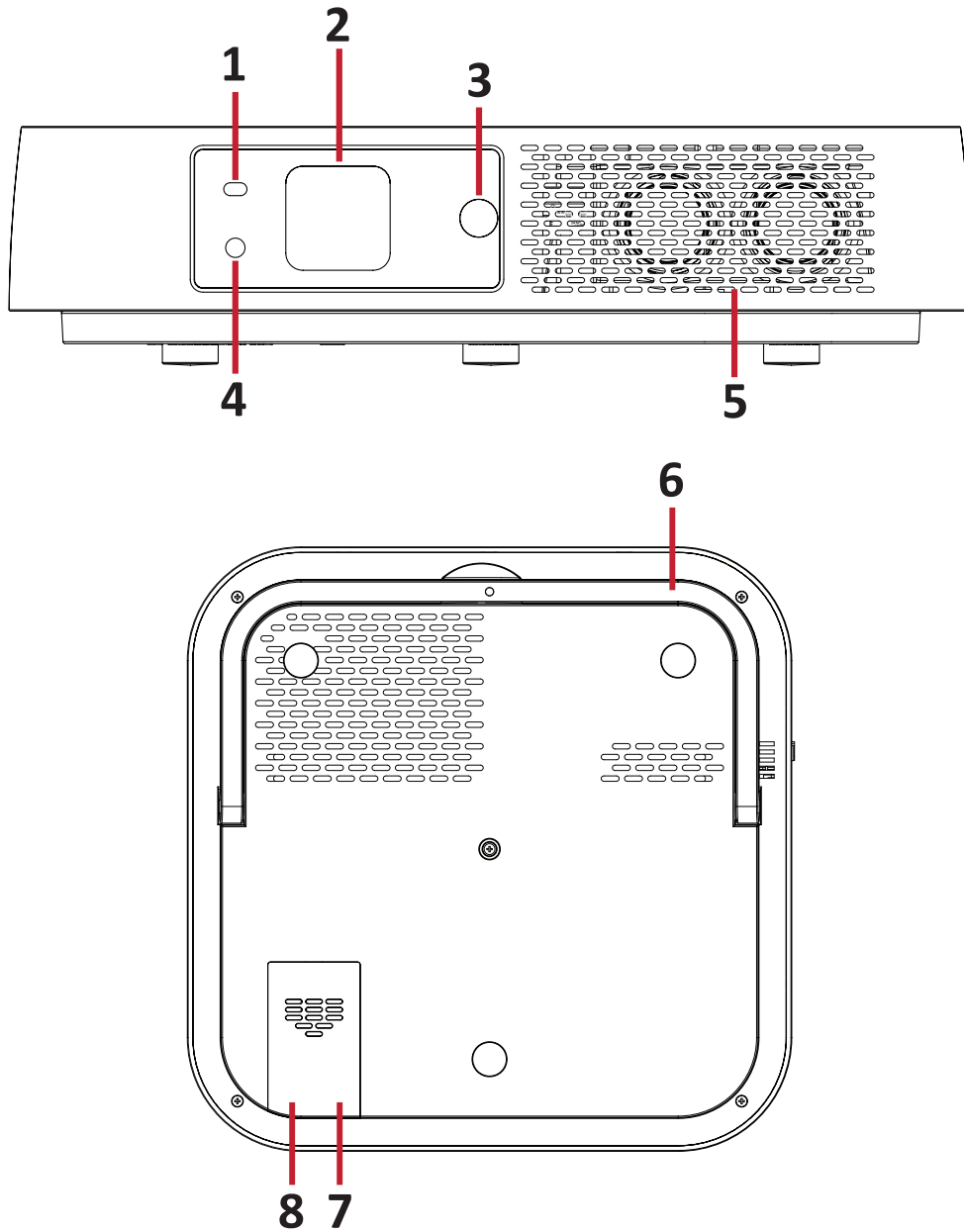

Item	Description
[1] Eye Protection Sensor	Detects close objects to the lens
[2] Lens	Projector Lens
[3] Auto Focus Camera	Automatically adjusts the focus
[4] IR Sensor	IR Sensor
[5] harman/kardon speakers	harman/kardon speakers
[6] Adjustor Foot	Stepless adjustment foot
[7] Wi-Fi Dongle	Wi-Fi Dongle socket
[8] Micro USB	USB for service use only

Connection Ports

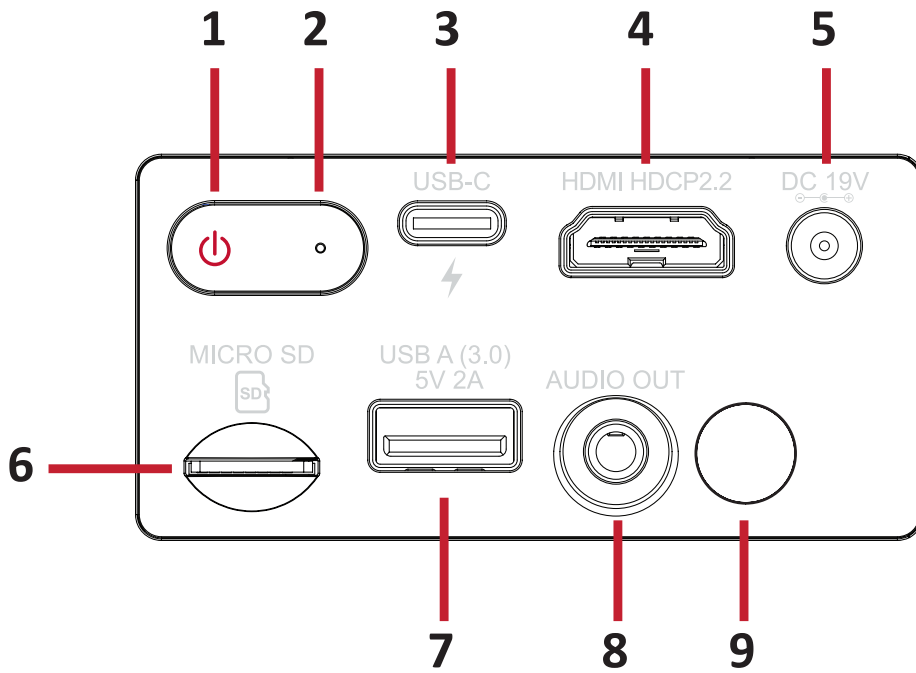















Port	Description
[1] Power Button	Toggles the projector between standby mode and on
[2] LED Indicator	LED Indicator
[3] USB-C ¹	USB-C port
[4] HDMI ²	HDMI port ³
[5] DC IN	Power input socket
[6] MICRO SD	Micro SD socket (SDXC up to 64 GB - FAT32/NTFS)
[7] USB A (5V/2A Out)	USB 3.0 Type A port (USB Reader - FAT32/NTFS)
[8] Audio Out (3.5 mm jack)	3.5 mm jack audio output socket
[9] IR Sensor	IR Sensor

¹ Please use the supplied USB-C cable, and ensure your USB-C device can support video transmission as well as charging. For more about charging, see page 19.

² Supports HDCP 2.0/HDMI 2.2.

³ iPhone/iPad users will need to buy an additional adapter. To avoid compatibility issues, please use Apple authorized accessories.

Remote Control

Button		Description
[1] Power		Turns the projector On or Off
[2] Source		Displays the input source selection bar.
[3] Focus		Automatically focus the image. To manually adjust, press and hold the Focus button on the remote control for three (3) seconds
[4] Setting		Displays the Setting menu.
[5] App Menu		Displays the Application menu.
[6] Up/Down/Left/Right		Navigates and selects the desired menu items and makes adjustments.
[7] OK		Confirms the selection.
[8] Return		Returns to the previous screen.
[9] Home		Access the Home screen.
[10] Volume Down		Decrease the volume level.
[11] Mute		Mute/Unmute.
[12] Volume Up		Increase the volume level.
[13] Network Setting		Displays Network settings.
[14] Audio Mode		Displays the audio mode settings.
[15] Bluetooth		Launch Bluetooth search.

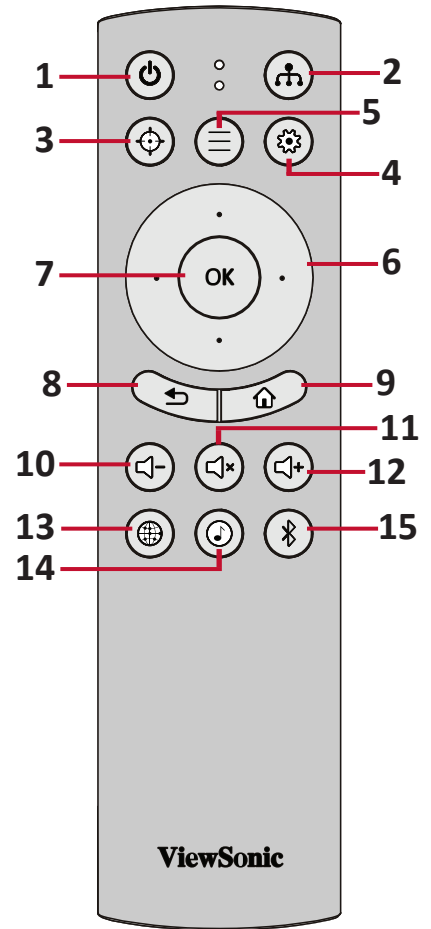

Remote Control

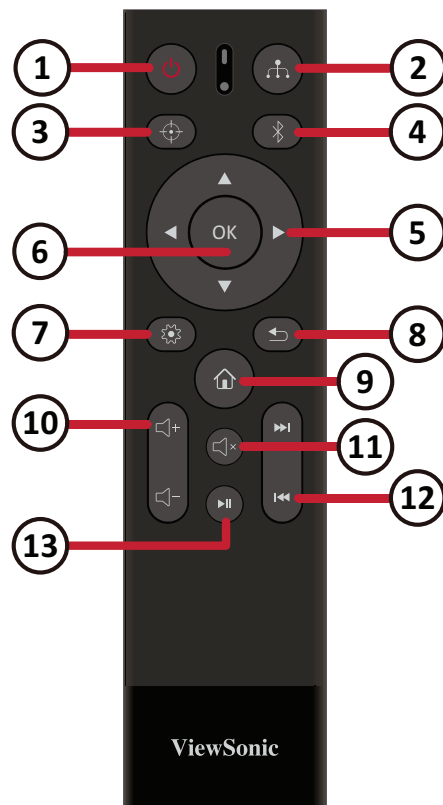

Button	Description
[1] Power	Turns the projector On or Off
[2] Source	Displays the input source selection menu
[3] Focus	Automatically focus the image
[4] Bluetooth Mode	Enable Bluetooth
[5] Up/Down/Left/Right	Navigate and select menu items; Keystone adjustment
[6] OK	Confirms the selection
[7] Setting	Displays the Setting menu
[8] Return	Returns to the previous screen
[9] Home	Access the Home screen
[10] Volume Control	Increase or decrease the volume level
[11] Mute	Mute the volume
[12] Next/Previous	Move to next/previous
[13] Play/Pause	Play or pause media

NOTE: Actual remote control may vary.

Remote Control - Effective Range

To ensure proper function of the remote control follow the steps below:

1. The remote control must be held at an angle within 30° perpendicular to the projector's IR remote control sensor(s).
2. The distance between the remote control and the sensor(s) should not exceed 8 m (26 ft.)

NOTE: Refer to the illustration for the location of the infrared (IR) remote control sensor(s).

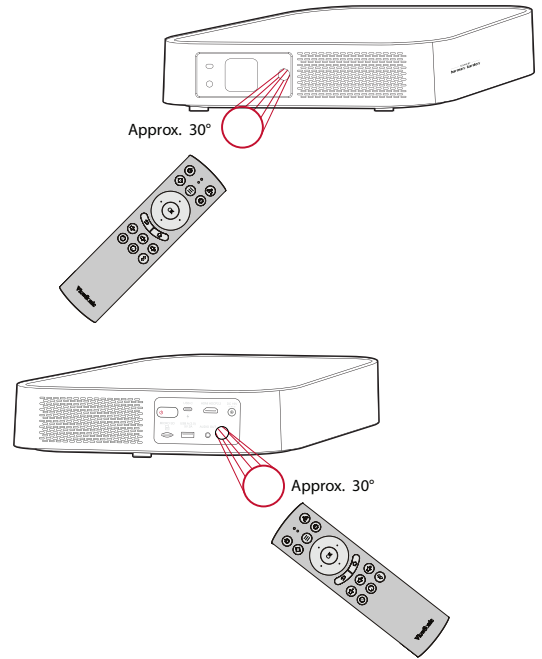

Remote Control - Replacing the Batteries

1. Remove the battery cover from the bottom of the remote control by pressing the finger grip and sliding it across.
2. Remove any existing batteries (if necessary) and install two AAA batteries.

NOTE: Observe the battery's polarities as indicated.

3. Replace the battery cover by aligning it with the base and pushing it back into position.

NOTE:

- Avoid leaving the remote control and batteries in excessive heat or a humid environment.
- Replace only with the same or equivalent type recommended by the battery manufacturer.
- If the batteries are drained or if you will not be using the remote control for an extended period of time, remove the batteries to avoid damage to the remote control.
- Dispose of the used batteries according to the manufacturer's instructions and local environment regulations for your region.

> Initial Setup

This section provides detailed instructions for the initial set up your projector.

Choosing a Location - Projection Orientation

Personal preference and room layout will decide the installation location. Consider the following:

- Size and position of your screen.
- Location of a suitable power outlet.
- Location and distance between the projector and other equipment.

The projector is designed to be installed in one of the following locations:

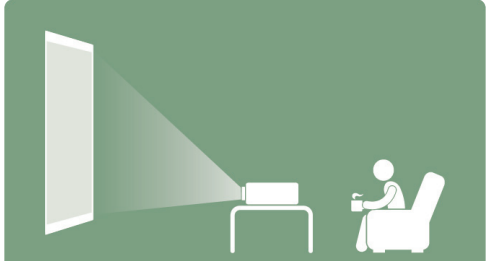
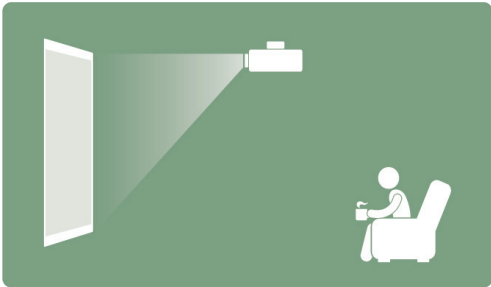
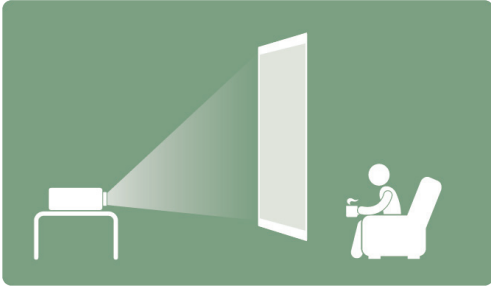
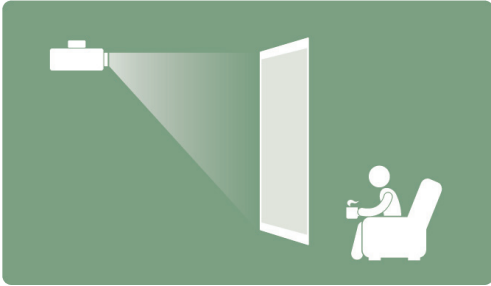
Location	
<p>Front Table</p> <p>The projector is placed near the floor in front of the screen.</p>	
<p>Front Ceiling</p> <p>The projector is suspended upside-down from the ceiling in front of the screen.</p>	
<p>Rear Table¹</p> <p>The projector is placed near the floor behind the screen.</p>	
<p>Rear Ceiling¹</p> <p>The projector is suspended upside-down from the ceiling behind the screen.</p>	

¹ A rear projection screen is required.

Projection Dimensions

- 16:9 Image on a 16:9 Screen

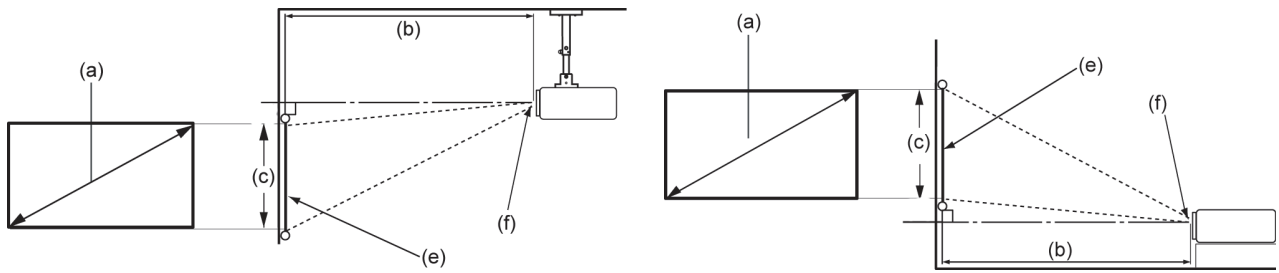

NOTE: (e) = Screen / (f) = Center of Lens

16:9 Image on a 16:9 Screen

(a) Screen Size		(b) Projection Distance				(c) Image Height		Image Width	
		Minimum		Maximum					
in.	cm	in.	m	in.	m	in.	cm	in.	mm
30	76.2	32.16	0.82	32.16	0.82	14.7	37.36	26.15	664
40	101.6	42.88	1.09	42.88	1.09	19.6	49.81	34.86	886
50	127	53.6	1.36	53.6	1.36	24.5	62.26	43.58	1107
60	152.4	64.32	1.63	64.32	1.63	29.4	74.72	52.29	1328
70	177.8	75.04	1.91	75.04	1.91	34.3	87.17	61.01	1550
80	203.2	85.76	2.18	85.76	2.18	39.2	99.62	69.73	1771
90	228.6	96.48	2.45	96.48	2.45	44.1	112.07	78.44	1992
100	254	107.2	2.72	107.2	2.72	49	124.53	87.16	2214

NOTE: There is a 3% tolerance among these numbers due to optical component variations. It is recommended to physically test the projection size and distance before permanently installing the projector.

Mounting the Projector

NOTE: If you buy a third party mount, please use the correct screw size. Screw size can vary depending on the thickness of the mounting plate.

1. To ensure the most secure installation, please use a ViewSonic® wall or ceiling mount.
2. Ensure the screws used to attach the mount to the projector meet the following specifications:
 - Screw type: M4 x 8
 - Maximum Screw Length: 8 mm
3. To access the ceiling mount points, remove the three (3) foot pads on the bottom of the projector.

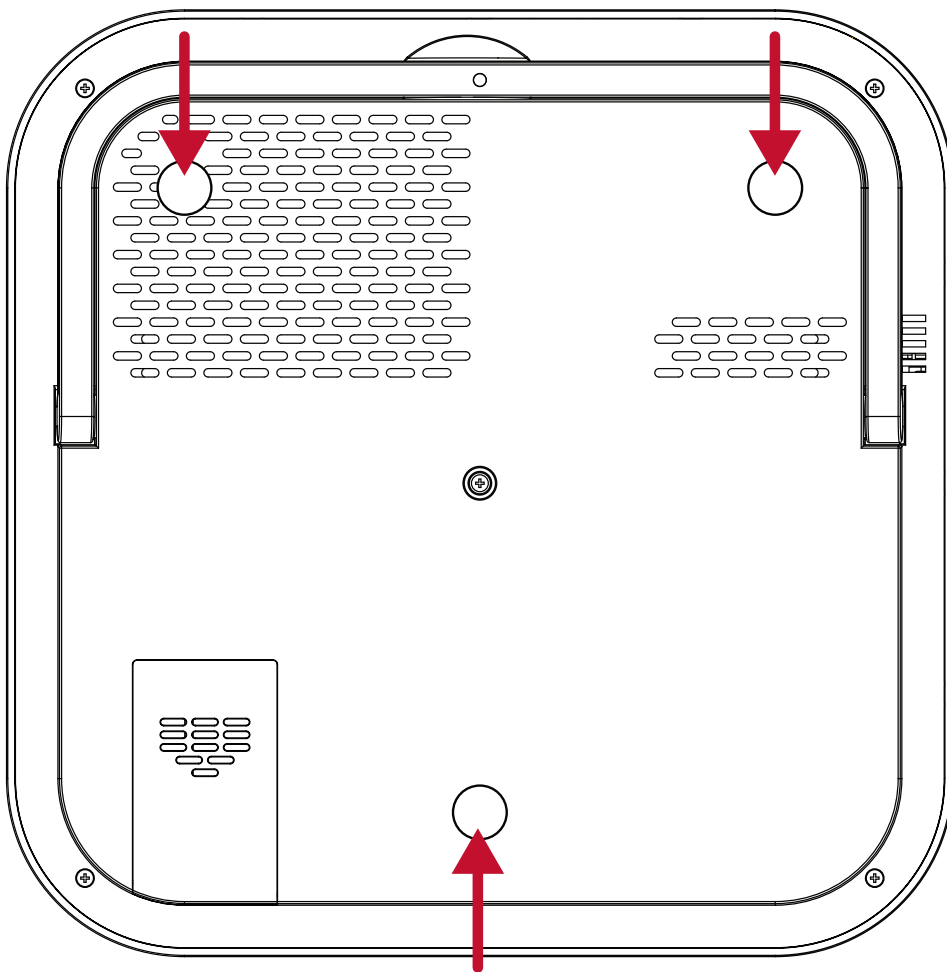

CAUTION:

- Avoid installing the projector near a heat source.
- Keep at least a 10 cm (3.9 in.) gap between the ceiling and the bottom of the projector.

> Making Connections

This section guides you on how to connect the projector with other equipment.

Connecting to Power

DC Power (Power Outlet)

1. Connect the power cord to the power adapter.
2. Connect the power adapter to the DC IN jack at the rear of the projector.
3. Connect the power cord plug to a power outlet. When connected, the status LED will turn red.

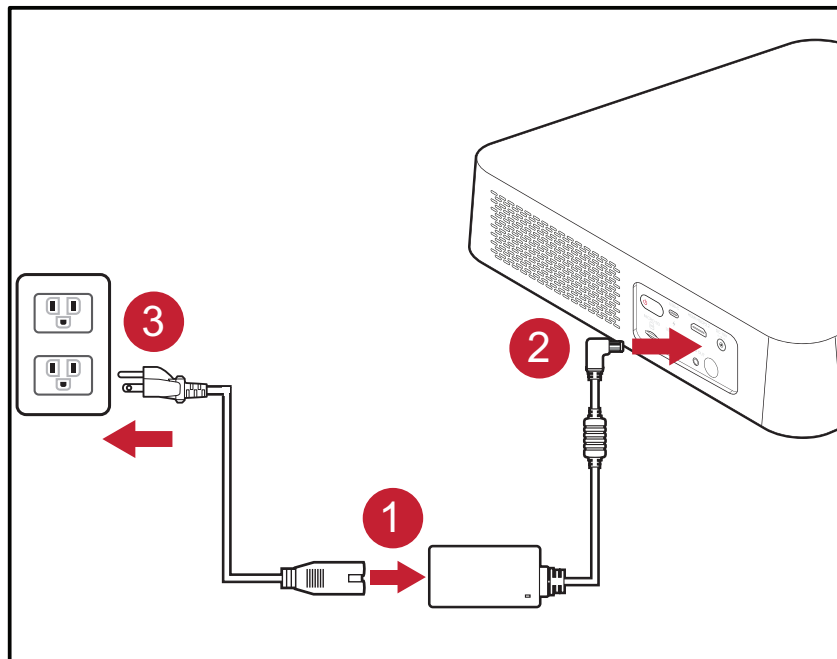

NOTE: When installing the projector, incorporate a readily accessible disconnect device in the fixed wiring, or connect the power plug to an easily accessible outlet near the unit. If a fault should occur during operation of the projector, use the disconnect device to switch off the power supply, or disconnect the power plug.

USB-C Power Bank

1. Connect one end of the USB Type-C cable to the **USB-C** port of the projector.
2. Connect the other end of the USB Type-C cable to the power bank.

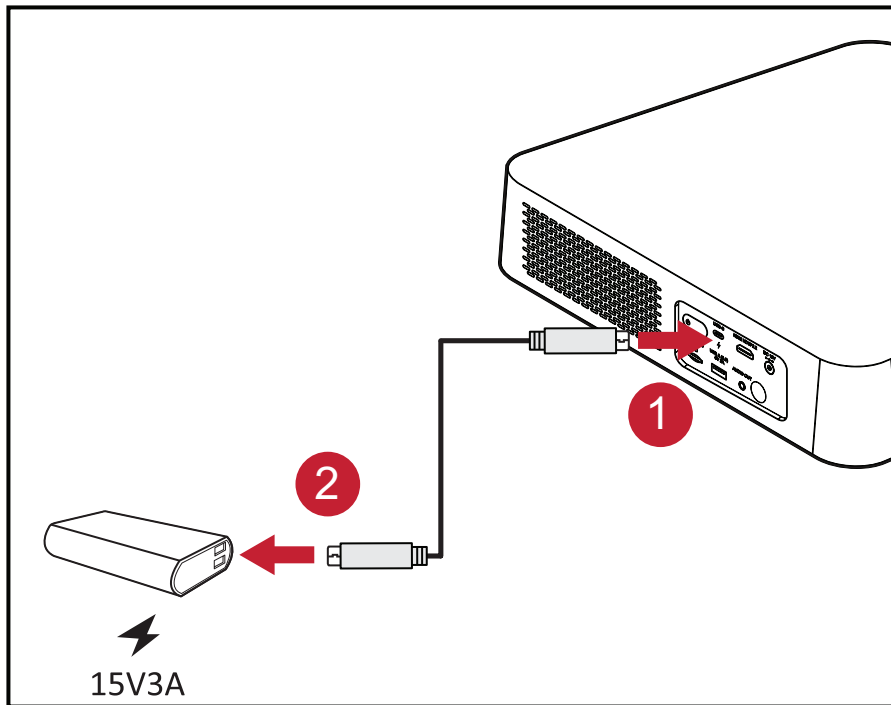

NOTE: The power bank should be 45W (15V/3A) at least, and support Power Delivery (PD) protocol output.

vRemote App

The vRemote App allows the user to control the projector via their personal mobile device. Users can change the input source, and mute/unmute or power on/off the projector.

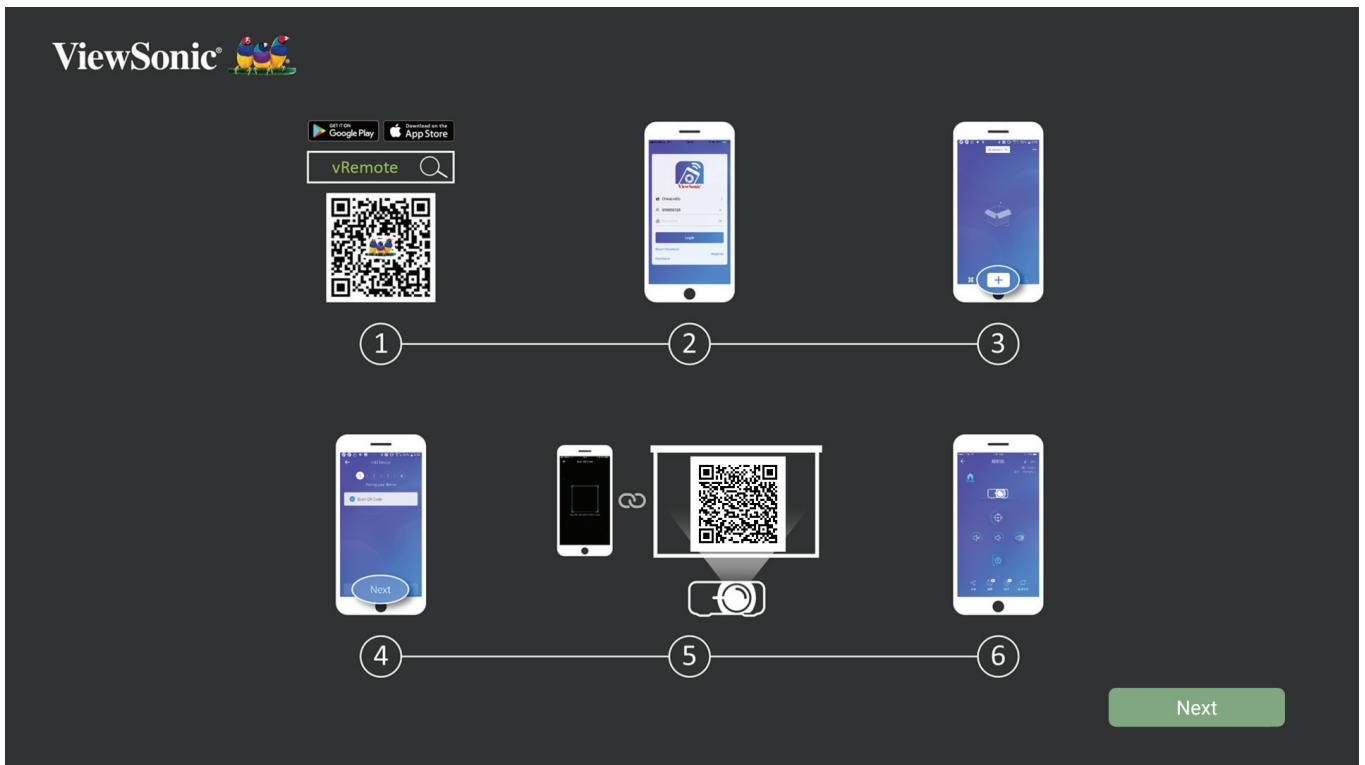

To use the ViewSonic Projector vRemote App:

NOTE: Ensure the vRemote App is open on the projector: **Home > Apps Center > vRemote.**

1. Download the App from Google Play or the Apple App Store and install it on your mobile device.
2. Open, register (if applicable), and log in to the application.
3. Press the “Add Device” icon.
4. Press the “Next” icon.
5. Use the camera to scan the QR Code projected by the projector.
6. Now you are ready to control the projector.

Connecting to External Devices

HDMI Connection

Connect one end of an HDMI cable to the HDMI port of your video device. Then connect the other end of the cable to the **HDMI** port (it supports HDCP 2.0/HDMI 2.2) of your projector.

NOTE: iPhone/iPad users will need to use an additional adapter.

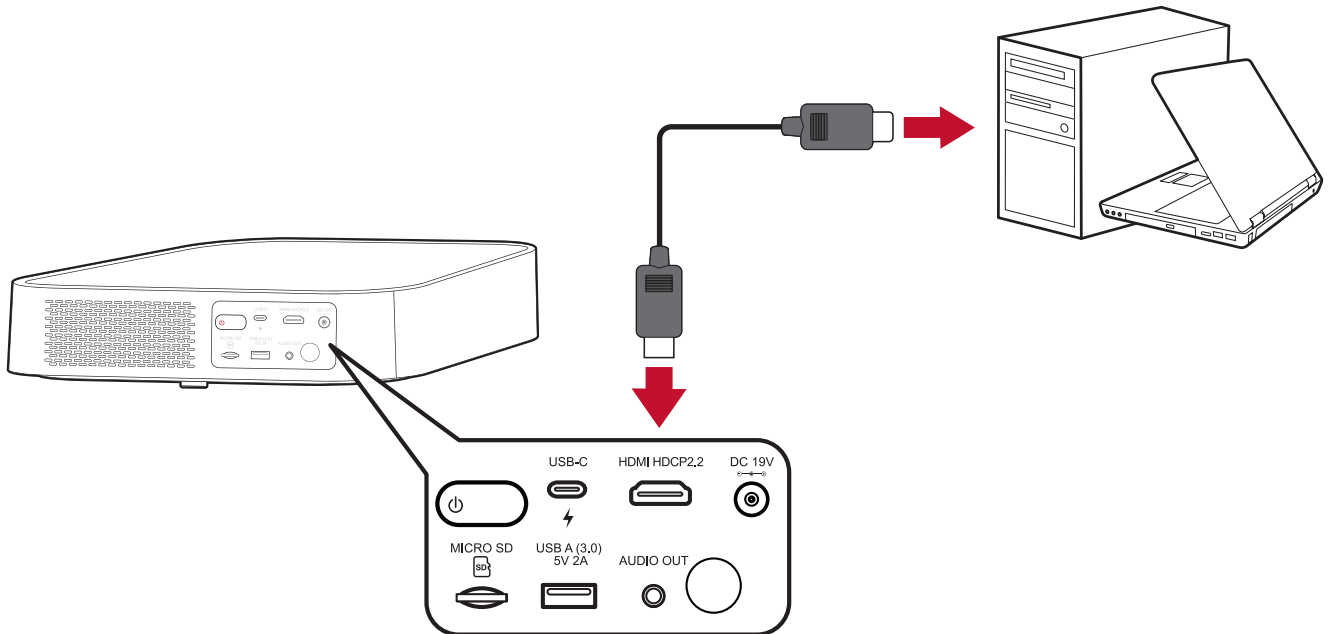

USB Connection

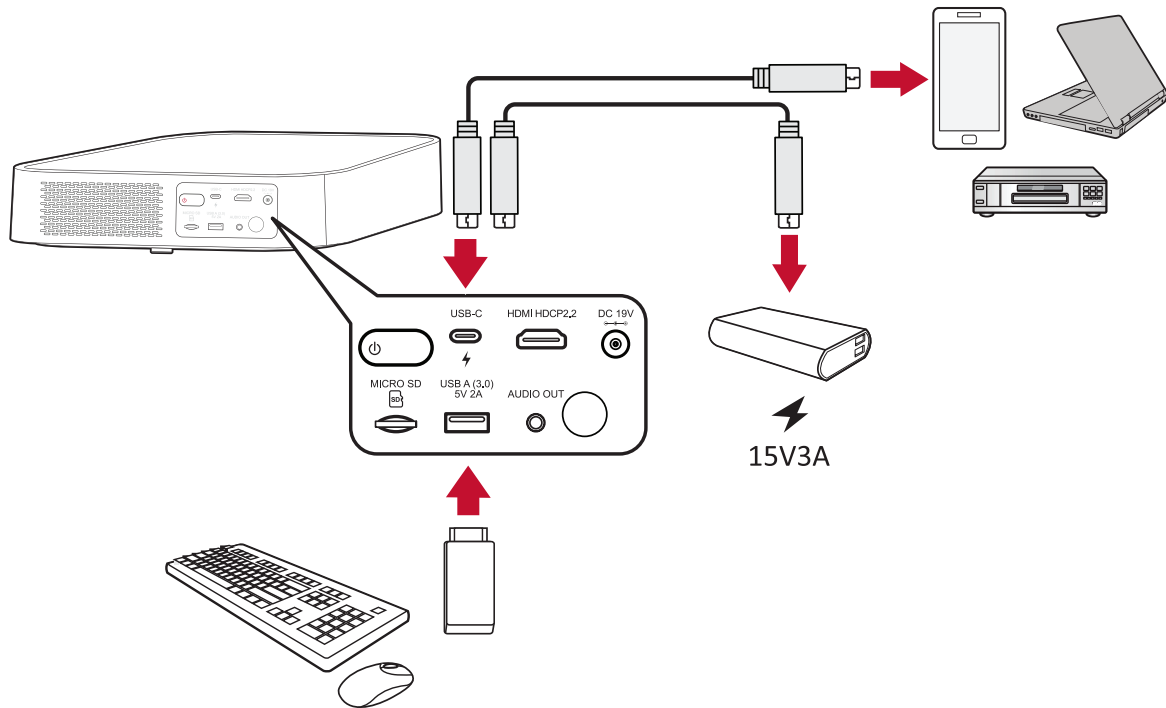

USB-C Connection

Connect one end of a USB Type-C cable to the USB-C port of your device. Then connect the other end of the cable to the **USB-C** port of your projector.

NOTE:

- Ensure your USB Type-C device can support video transmission.
- The M2 can also use a USB-C connected power bank to turn on the system. However, the brightness level will be limited to 50% and 30% when the **Light Source Level** is set as **Full** or **Eco** respectively.

USB Type-A Connection

Connect one end of a USB Type-A cable to the USB-A port of your device (if applicable). Then connect the other end of the cable to the **USB A** port of your projector.

Additionally, you can connect a keyboard, a mouse, dongles, storage devices, etc. to the projector's **USB-A** port. To learn more about managing storage device, e.g. USB Flash Drive, content, see page 60.

Wireless Screen Mirroring

Screen Mirroring provides a 5GHz Wi-Fi connection for users to mirror the screen on their personal device.

NOTE: Ensure your device is connected to the same network as the projector.



For iOS:

1. Access the drop down control menu.
2. Select the “Screen Mirroring” icon.
3. Choose “ViewSonic PJ-XXXX”.

For Android:

1. Download and install the “Google Home” application and open it.
2. Select the Account icon at the lower-right corner of the screen.
3. Select the “Mirror Device” function.
4. Choose “ViewSonic PJ-XXXX”.

NOTE: Some Android devices support direct “Casting”. If your device does, go to the Casting feature and choose “ViewSonic PJ-XXX” from the list of available devices.

Connecting to Audio

Bluetooth

The projector is equipped with Bluetooth that allows the user to connect the projector to their Bluetooth device wirelessly for audio playback, e.g. Bluetooth speaker.

NOTE: The M2 projector doesn't support audio streaming from your mobile device.

To connect and pair your device:

1. Press the **Bluetooth** button on the remote control, or go to: **Setting > Basic Settings > Bluetooth Device Search**.

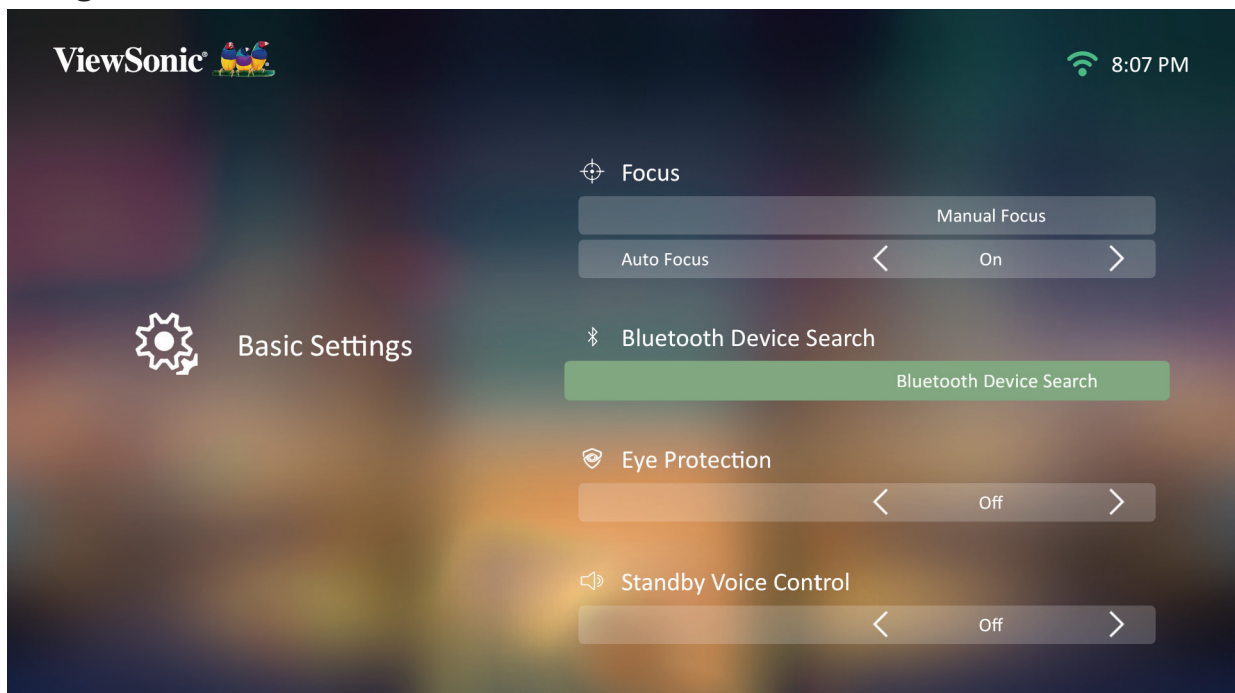

2. Ensure that **Bluetooth Device Search** is **On** and use the Left and Right directional buttons on the remote control to adjust if needed.

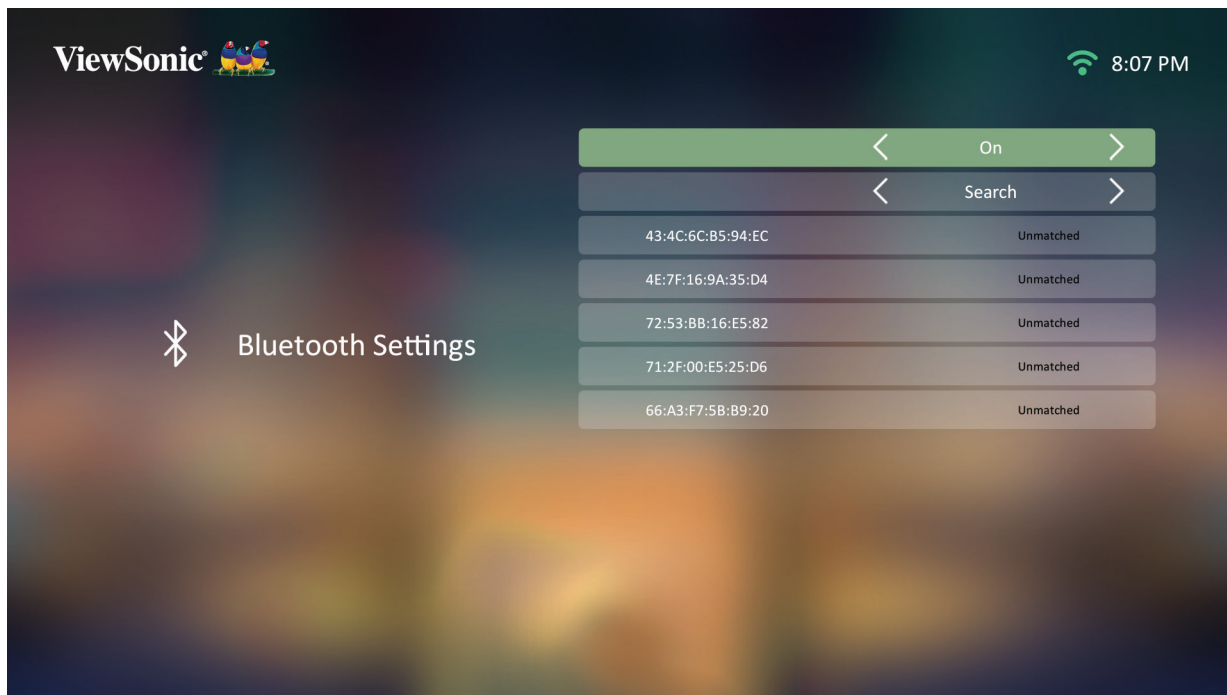

3. Once **On**, the projector will search for nearby Bluetooth devices. Select your device from the list and press **OK** on the remote control.

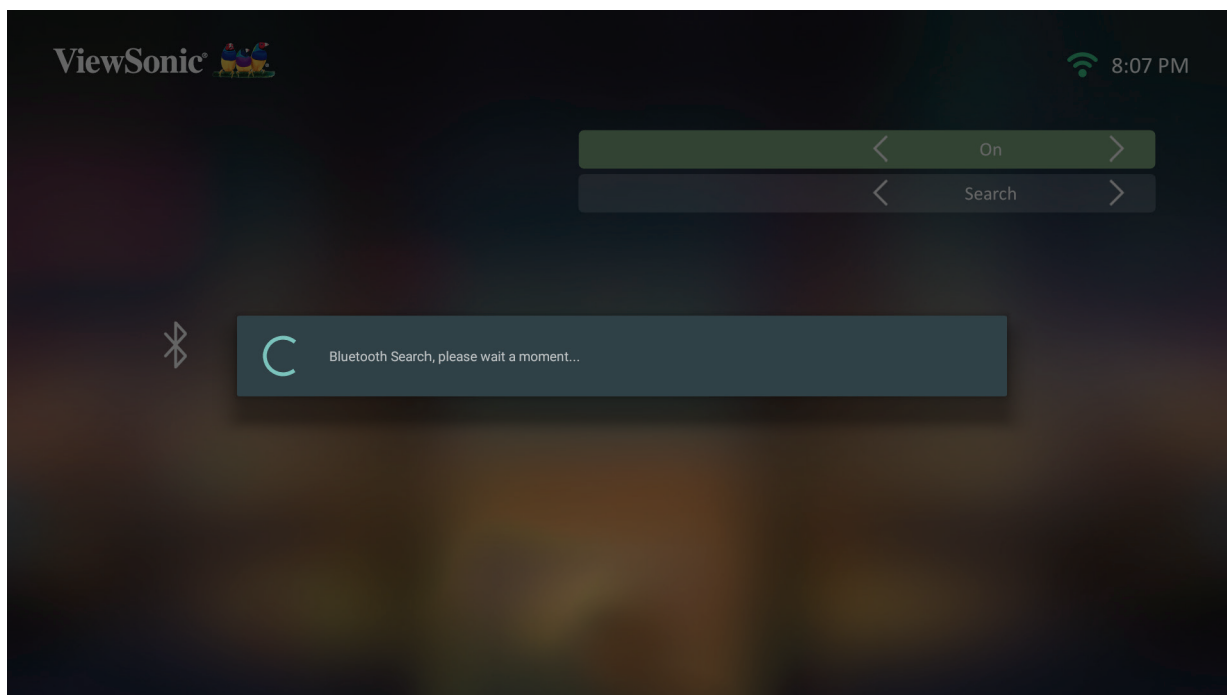

Voice Control

The M2 projector is embedded with voice control technology, making projector control even easier. Voice Control allows the user to easily control the projector via Google Home or Alexa.

NOTE: Alexa & Google Assistant are only available in English. The number of supported commands and usage scenarios varies with each country.

Alexa Voice Control

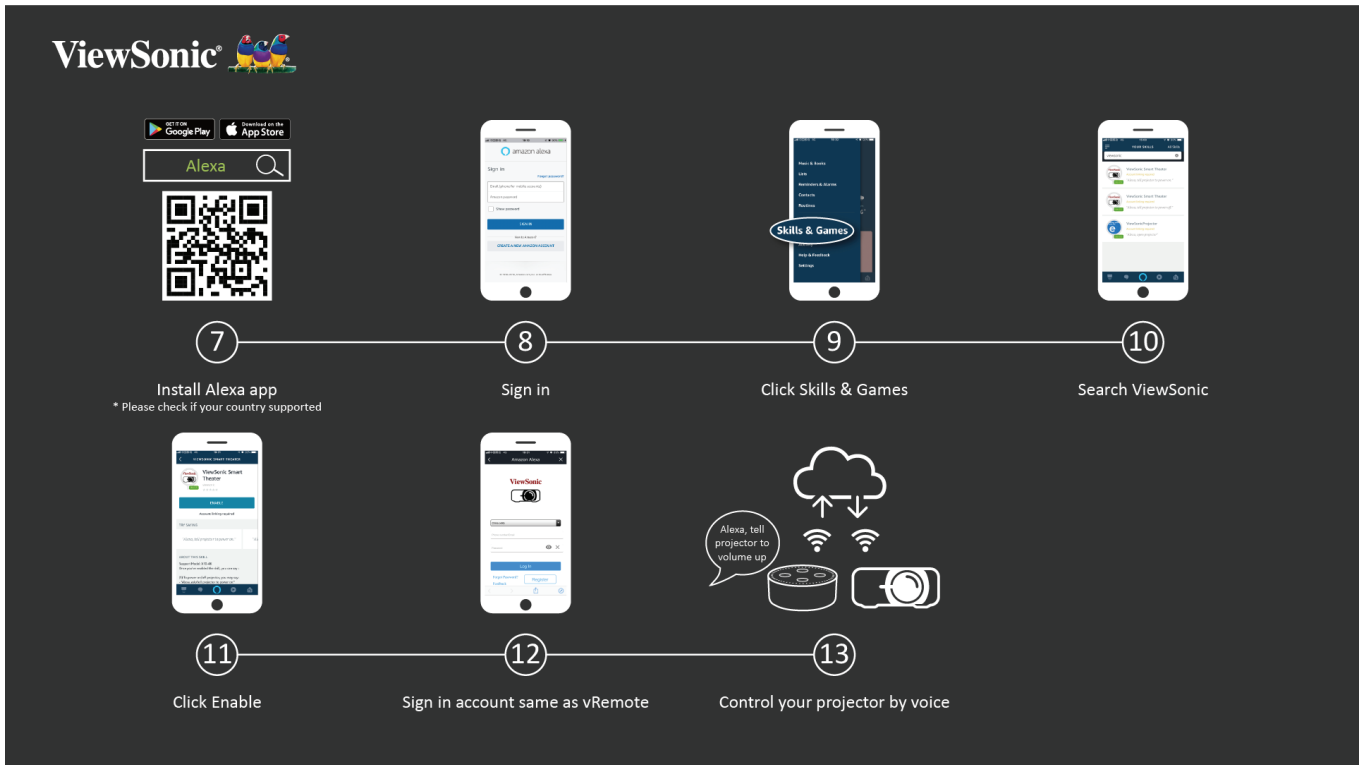

To enable Alexa Voice Control:

1. Ensure the vRemote App is installed and paired. Please refer to page 20, **steps 1-6**.

After installing and pairing the vRemote App:

7. Download the Alexa App from Google Play or the Apple App Store and install it on your mobile device.

8. Open and log in to the application.

9. Select “Skills & Games” at the top-left bar.

10. Search for “ViewSonic” in “All Skills”.

NOTE: There are two skills, “ViewSonic Smart Theater” and “ViewSonic Advanced Smart Theater”.

11. Press the “Enable” icon.

12. Sign in with your vRemote App account.

13. Now you can control your projector by voice.

Alexa Voice Control Commands

ViewSonic Smart Theater

NOTE: The default name for [Device] is [My device12345]. However, please note “12345” is the device’s ID, and each device is different.

Command	Description
“Alexa, Turn On [Device].”	Power on the device
“Alexa, Turn Off [Device].”	Power off the device
“Alexa, Set volume of [Device] to [0~50].”	Adjust the Volume level
“Alexa, Mute [Device].”	Mute the Volume
“Alexa, Unmute [Device].”	Unmute the Volume
“Alexa, Change [Device] to HDMI Input.”	Change the HDMI input source
“Alexa, set [Device] to HDMI Input.”	Set the HDMI input source
“Alexa, set [Device] to USB-C Input.”	Set the device to USB-C input
“Alexa, set [Device] to Home Page.”	Go to the Home Screen
“Alexa, set [Device] to Auto Focus.”	Automatically focus the image

ViewSonic Advanced Smart Theater

Command	Description
“Alexa, Ask/Tell ViewSonic to Power On.”	Power on the device
“Alexa, Ask/Tell ViewSonic to Power Off.”	Power off the device
“Alexa, Ask/Tell ViewSonic to Volume Up.”	Increase the Volume level
“Alexa, Ask/Tell ViewSonic to Volume Down.”	Decrease the Volume level
“Alexa, Ask/Tell ViewSonic to Volume 0~50.”	Adjust the Volume level
“Alexa, Ask/Tell ViewSonic to Mute.”	Mute the Volume
“Alexa, Ask/Tell ViewSonic to Unmute.”	Unmute the Volume
“Alexa, Ask/Tell ViewSonic to HDMI.”	Set the HDMI input source
“Alexa, Ask/Tell ViewSonic to USB-C.”	Set the device to USB-C input
“Alexa, Ask/Tell ViewSonic to Home.”	Go to the Home Screen
“Alexa, Ask/Tell ViewSonic to Focus.”	Automatically focus the image

NOTE: ViewSonic Advanced Smart Theater is recommended as more commands are available.

Google Assistant Voice Control

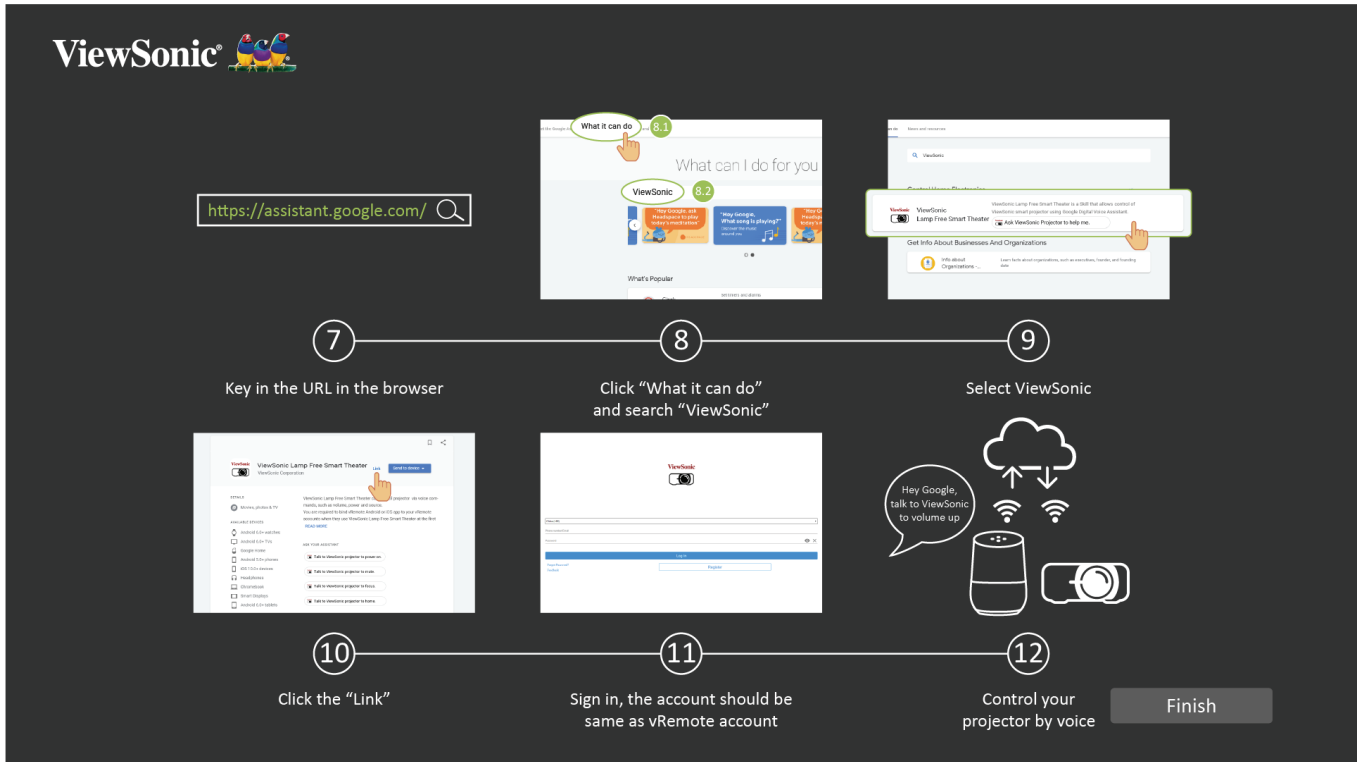

To enable Google Assistant Voice Control:

1. Ensure the vRemote App is installed and paired. Please refer to page 20, **steps 1-6**.

After installing and pairing the vRemote App:

7. Open your web browser and go to: <https://assistant.google.com>.

8. Click, "What it can do" and search for "ViewSonic".

9. Select "ViewSonic Lamp Free Smart Theater".

10. Click the "Link".

11. Sign in with your vRemote App account.

12. Now you can control your projector by voice.

Google Assistant Voice Control Commands

Command	Description
“Hey Google, talk to ViewSonic to Power On.”	Power on the device
“Hey Google, talk to ViewSonic to Power Off.”	Power off the device
“Hey Google, talk to ViewSonic to Volume Up.”	Increase the Volume level
“Hey Google, talk to ViewSonic to Volume Down.”	Decrease the Volume level
“Hey Google, talk to ViewSonic to set Volume to [0~50].”	Adjust the Volume level
“Hey Google, talk to ViewSonic to Mute.”	Mute the Volume
“Hey Google, talk to ViewSonic to Unmute.”	Unmute the Volume
“Hey Google, talk to ViewSonic to change input to [HDMI 1].”	Set the HDMI input source
“Hey Google, talk to ViewSonic to change input to USB-C.”	Set the USB-C input source
“Hey Google, talk to ViewSonic to Home.”	Go to the Home Screen
“Hey Google, talk to ViewSonic to Focus.”	Automatically focus the image

Connecting to Networks

Wi-Fi Connection

With the included Wi-Fi dongle, you can easily connect to wireless internet networks.

To connect to a Wi-Fi network:

1. Insert the Wi-Fi dongle into the projector's Wi-Fi dongle socket.
2. Go to: **Home > Setting > Network Settings > Wi-Fi**
3. Press **Left** or **Right** on the remote control to select **On**.



4. Available Wi-Fi networks will then be displayed. Select one of the available Wi-Fi networks.



5. If you connect to a secure Wi-Fi network, you must enter the password when prompted.

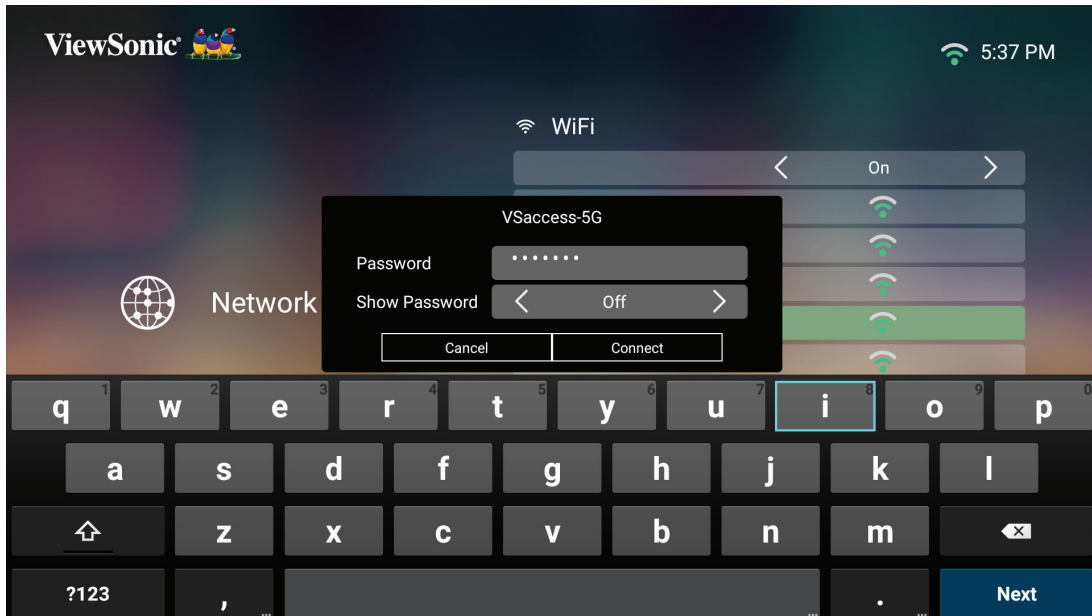

Custom SSID

1. Ensure the Wi-Fi dongle is plugged into the projector's Wi-Fi dongle socket.
2. Go to: **Home > Setting > Network Settings > Wi-Fi**
3. Press **Left** or **Right** on the remote control to select **On**.
4. From the available Wi-Fi networks list select **Others** and press **OK** on the remote control.

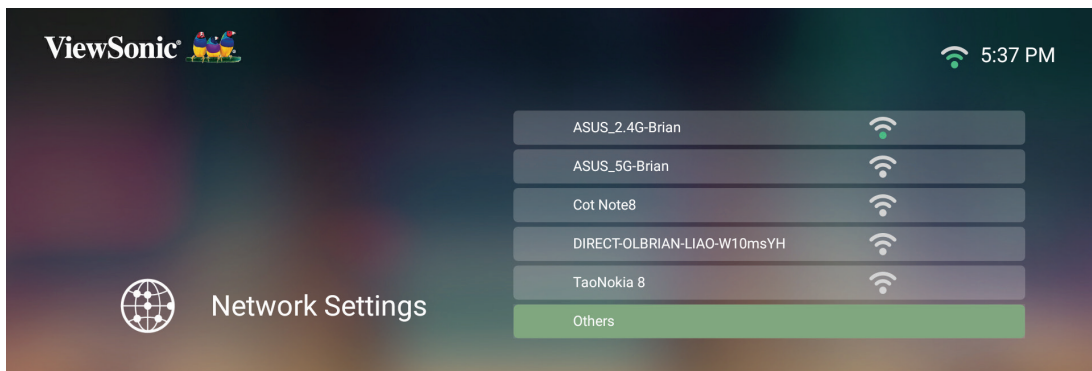

5. Enter the SSID and select the security level.

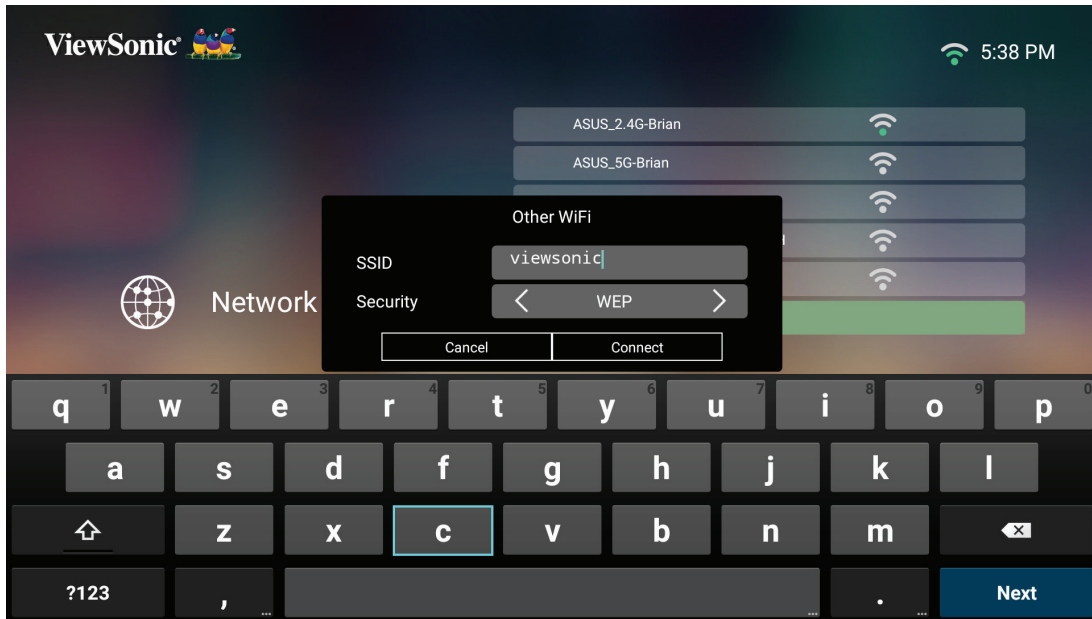

6. Enter the password when prompted.

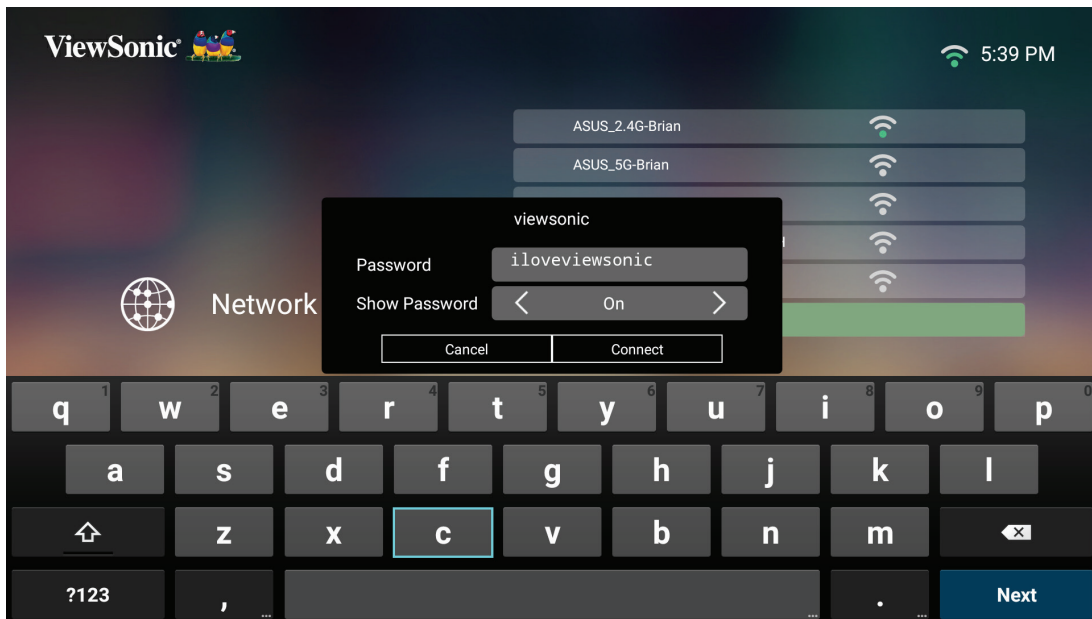

NOTE: It is recommended to let the system configure the network settings automatically by choosing **Automatic** for **Configure IP**.

> Using the Projector

Starting Up the Projector

1. Ensure the projector's power cord is properly connected to a power outlet.
2. Press the **Power** button to turn on the projector.

NOTE: The Status LED will be blue during startup.

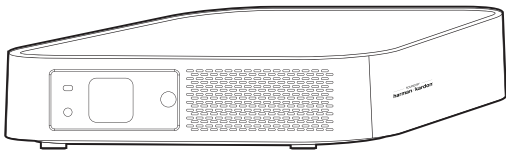

First Time Activation

If the projector is activated for the first time, you will need to select your Preferred Language, Projection Orientation, Network Settings, and Source Input. Follow the on-screen instructions using the **OK** and **Up/Down/Left/Right** buttons on the remote control. When the Finish screen appears, this indicates the projector is ready to use.

Preferred Language

Select the desired language and press **OK** to confirm the selection.



Projection Orientation

Select the preferred projection orientation and press **OK** to confirm the selection. For more information, see page 15.



Network Settings

Insert the Wi-Fi dongle into the Wi-Fi dongle socket under the projector. Then select one of the available options. For more information, see page 30.

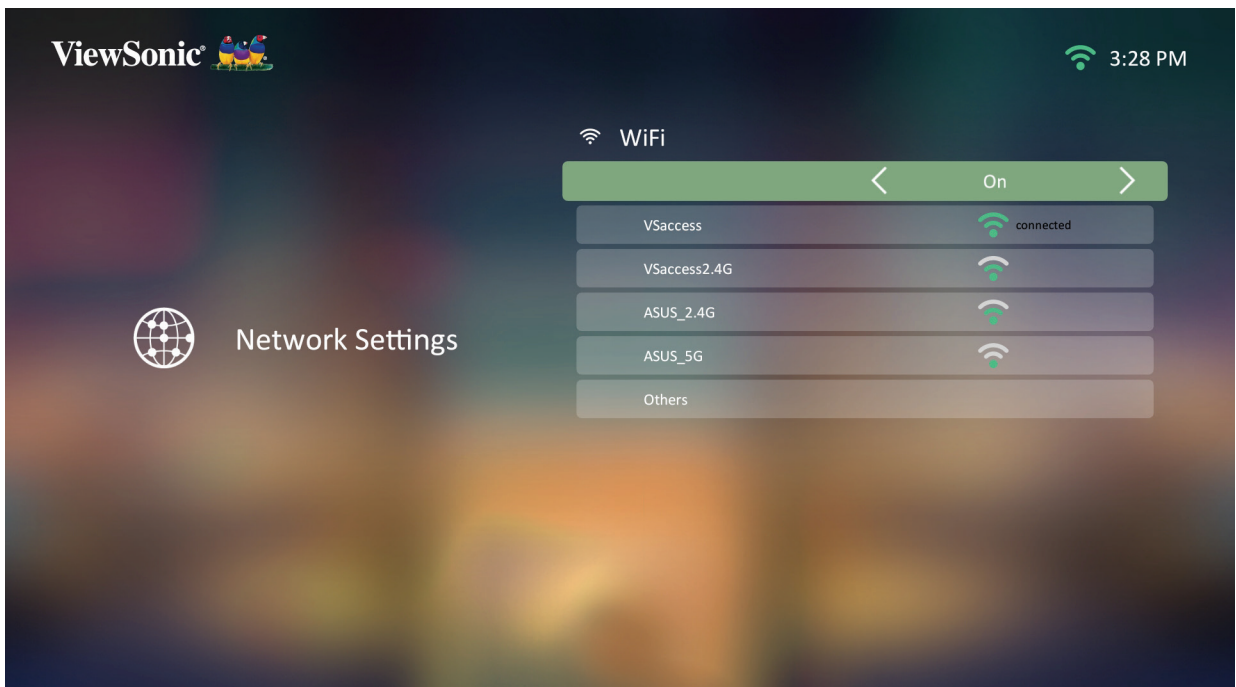

Source Input

Quickly access the **Source Input** menu by pressing the **Down** button on the remote control when at the **Home Screen**. Additionally, you can press the **Source** button on the remote control. For more information, see page 36.

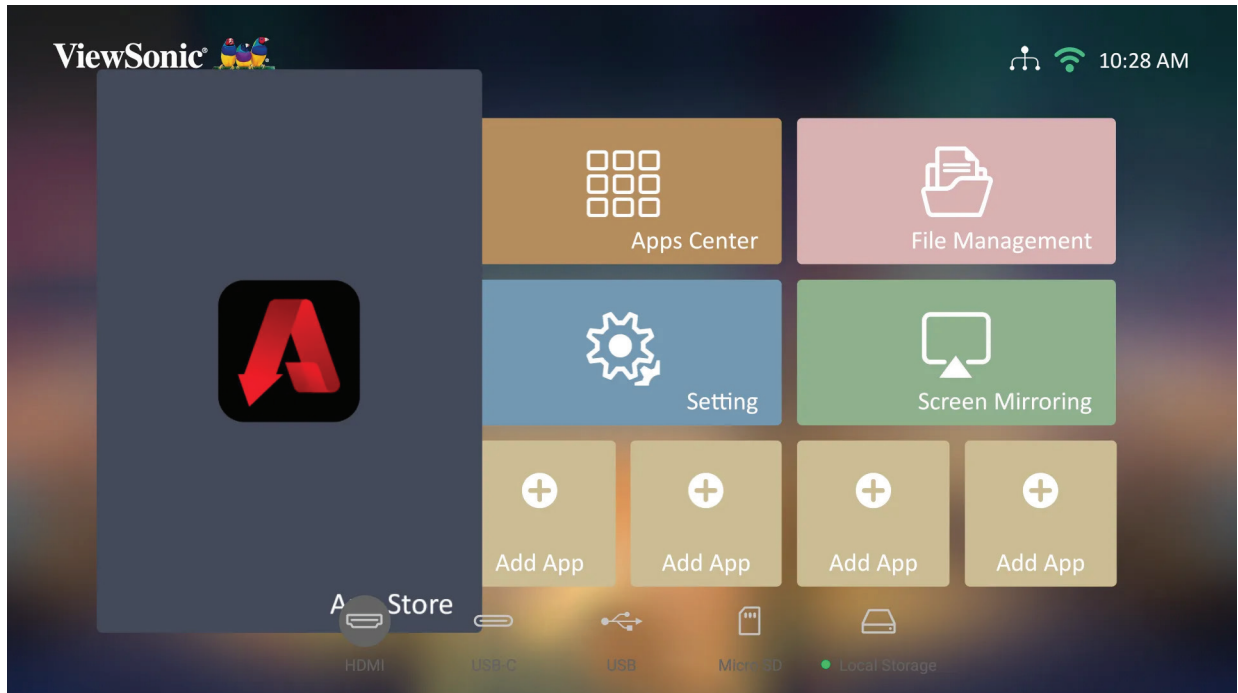

NOTE: If **Auto Focus** is On, the automatic focus adjustment will run every time the projector is turned on.

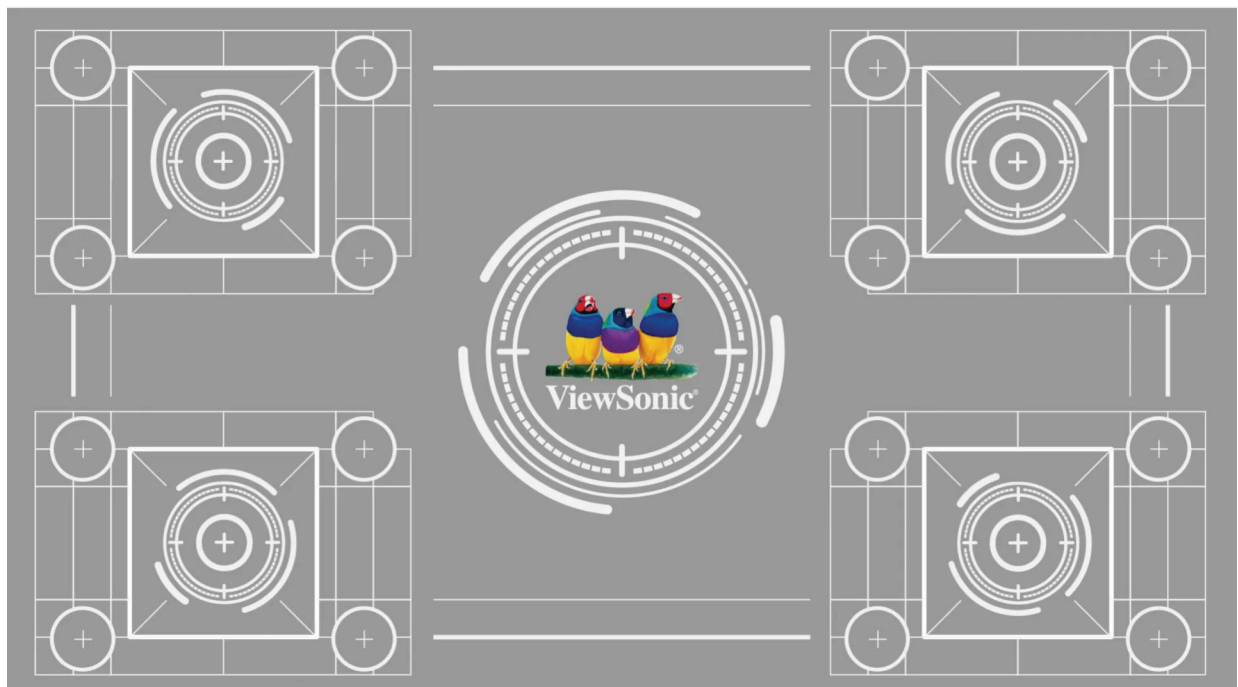

Selecting an Input Source

The projector can be connected to multiple devices at the same time. However, it can only display one full screen at a time.

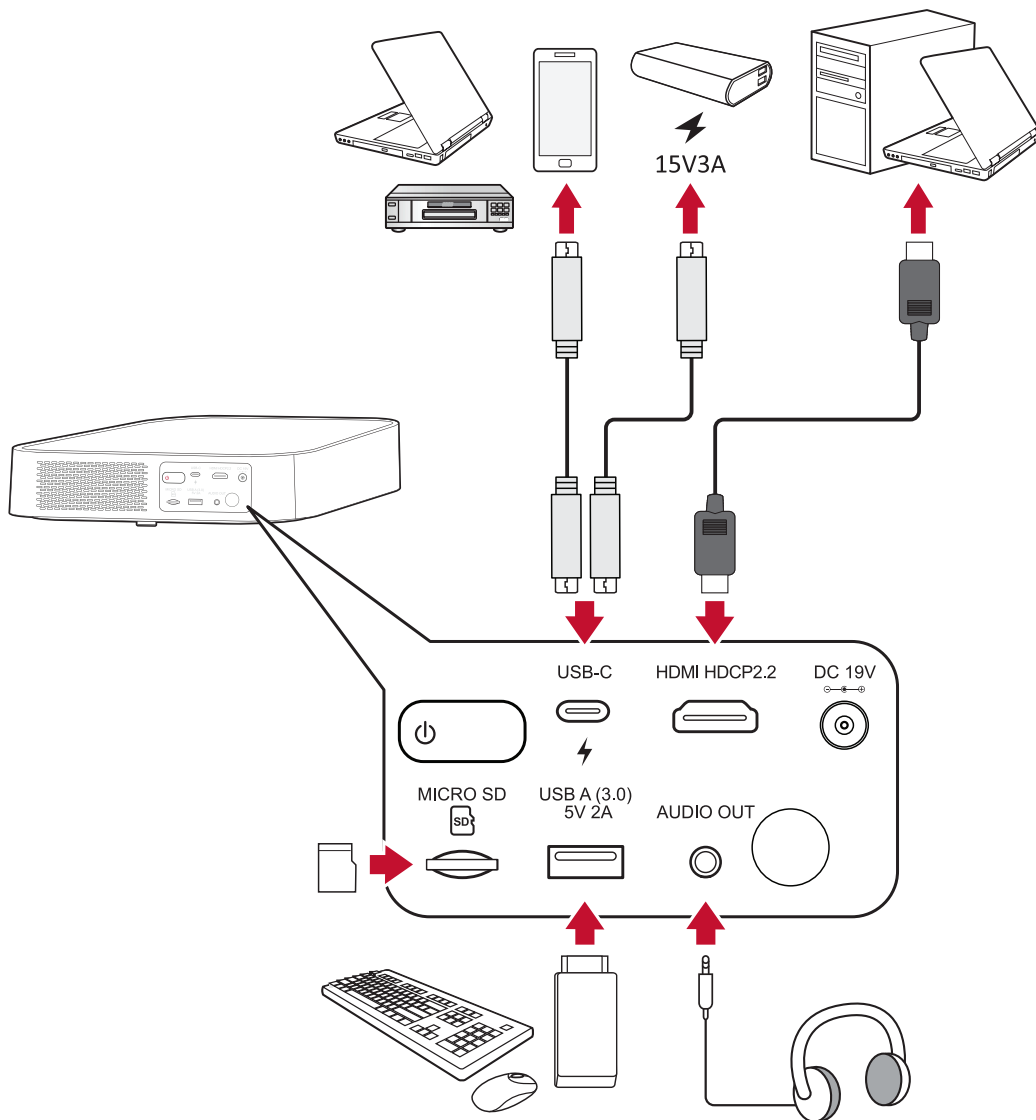

The projector will automatically search for input sources. If multiple sources are connected, press the **Source** button on the remote control to select the desired input, or press the **Down** button when at the **Home Screen** until the source list is displayed.

NOTE: Ensure the connected sources are also turned on.

Adjusting the Projected Image

Adjusting the Projector's Height and Projection Angle

The projector is equipped with one (1) adjuster foot. Adjusting the foot will change the projector's height and the vertical projection angle. Carefully adjust the foot to fine tune the projected image's position.

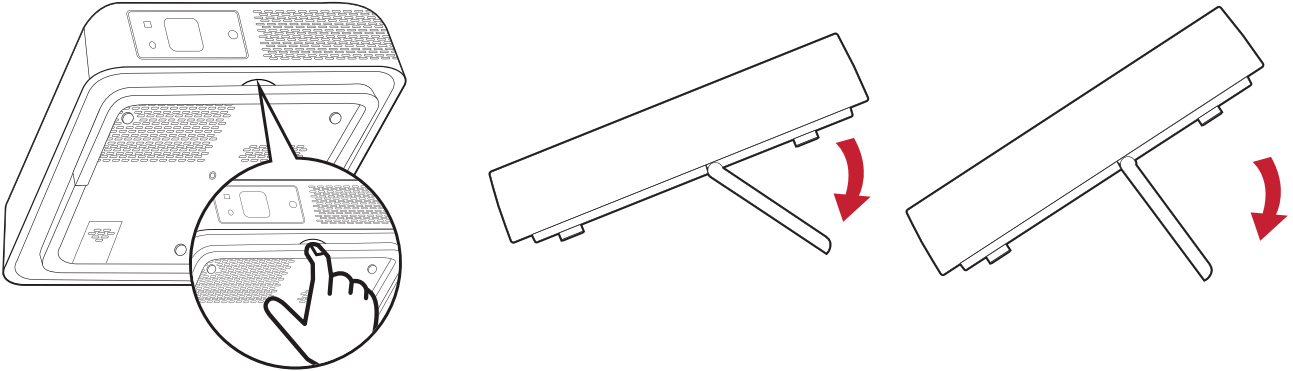

NOTE: If the projector is not placed on a flat surface or the screen and the projector are not perpendicular to each other, the projected image can become trapezoidal. However, the “Auto Vertical Keystone” function will correct the issue automatically.

Shutting Down the Projector

1. Press the **Power** button on the projector or remote control and the following message will appear:

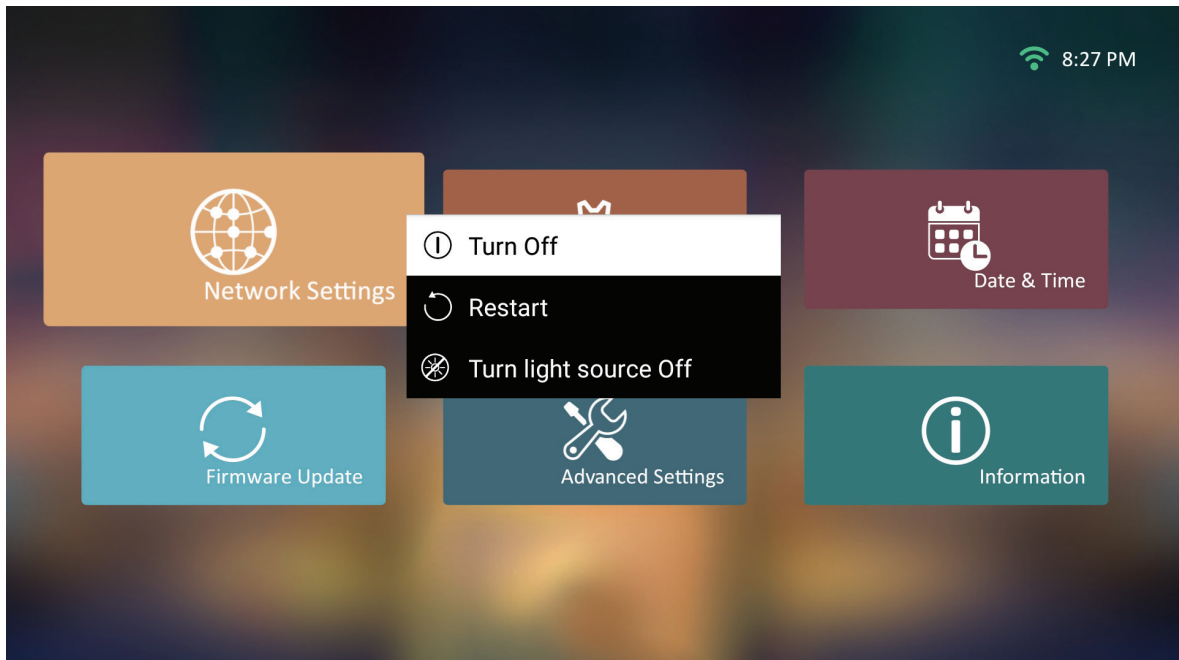

2. Press the **Up/Down** buttons on the remote control to select **Turn Off** and press **OK** on the remote control.
3. The Status LED will turn solid red once turned off.

NOTE: When pressing **Power** on the remote control, you can choose from three options: Turn Off, Restart, and Turn light source Off.

Input Source Selected - On-Screen Display (OSD) Tree

After your input source is selected, you can adjust the **Image Setting** and **Advanced** menus.

Main Menu	Sub-menu	Menu Option		
Image Setting	Color Mode	Brightest		
		TV		
		Movie		
		Gaming		
		User 1		
		User 2		
	Brightness	(-/+ , 0~100)		
	Contrast	(-/+ , -50~50)		
	Color Temp	6500K		
		7500K		
		9300K		
		User	Red Gain	(-/+ , 0~199)
			Green Gain	(-/+ , 0~199)
			Blue Gain	(-/+ , 0~199)
	Red Offset		(-/+ , 0~199)	
	Green Offset	(-/+ , 0~199)		
	Blue Offset	(-/+ , 0~199)		
	Tint	(-/+ , -99~99)		
	Saturation	(-/+ , 0~199)		
	Sharpness	(-/+ , 0~31)		
Gamma	1.8			
	2.0			
	2.2			
	2.35			
	2.5			
	sRGB			
Cubic				

Main Menu	Sub-menu	Menu Option	
Image Setting	Color Management	Primary Color	Red
			Green
			Blue
			Cyan
			Magenta
			Yellow
		Hue	(-/+, -63~63)
		Saturation	(-/+, -15~15)
	Gain	(-/+, -31~31)	
	Reset Current Color Settings	Reset	
Cancel			
Advanced	Aspect Ratio	Auto	
		4:3	
		16:9	
		16:10	
		2.35:1	
		Anamorphic	
		Native	
	HDR	Auto	
		SDR	
	EOTF	Low	
		Mid	
		High	
	Frame Interpolation	Low	
		Mid	
		High	
		Off	
	HDMI Setting	Range	Auto
			Full
			Limited

Main Menu	Sub-menu	Menu Option	
Advanced	3D Settings	3D Sync	Auto
			Off
			Frame Sequential
			Frame Packing
			Top-Bottom
			Side-by-Side
		3D Sync Invert	Disable
			Invert
	harman/kardon	Audio Mode	Movie
			User
		100Hz	
		500Hz	
		1500Hz	
		5000Hz	
		10000Hz	
		Audio Volume	(-/+ , 0~50)
		Mute	Off
On			

Image Setting Menu

After your input source is selected, you can adjust the **Image Setting** menu.

To access the **Image Setting** menu:

1. Press **Setting** on the remote control.

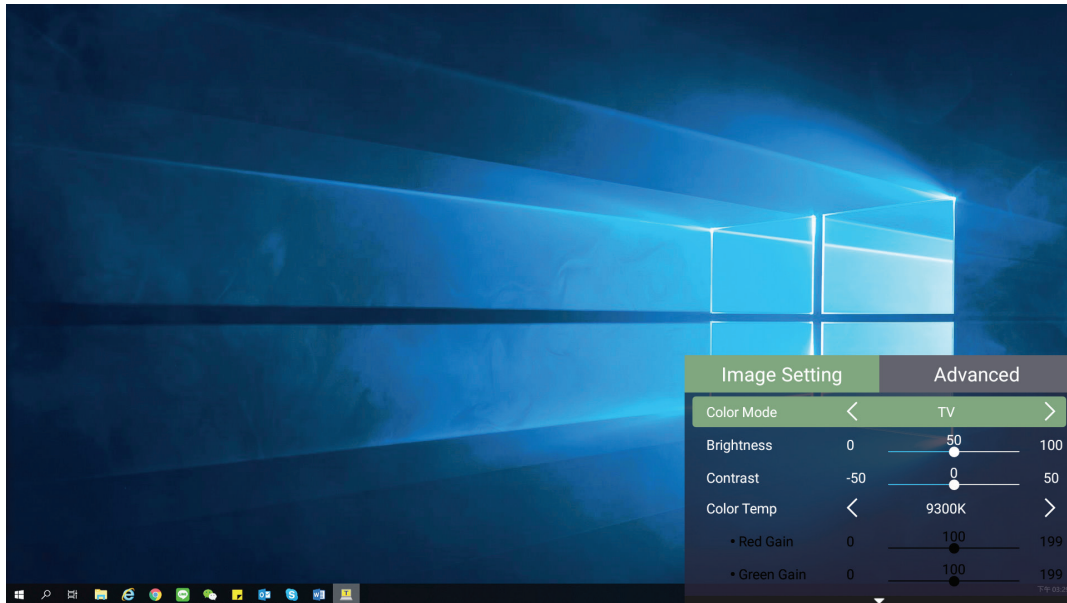

2. Use the **Up/Down** buttons to select a menu.

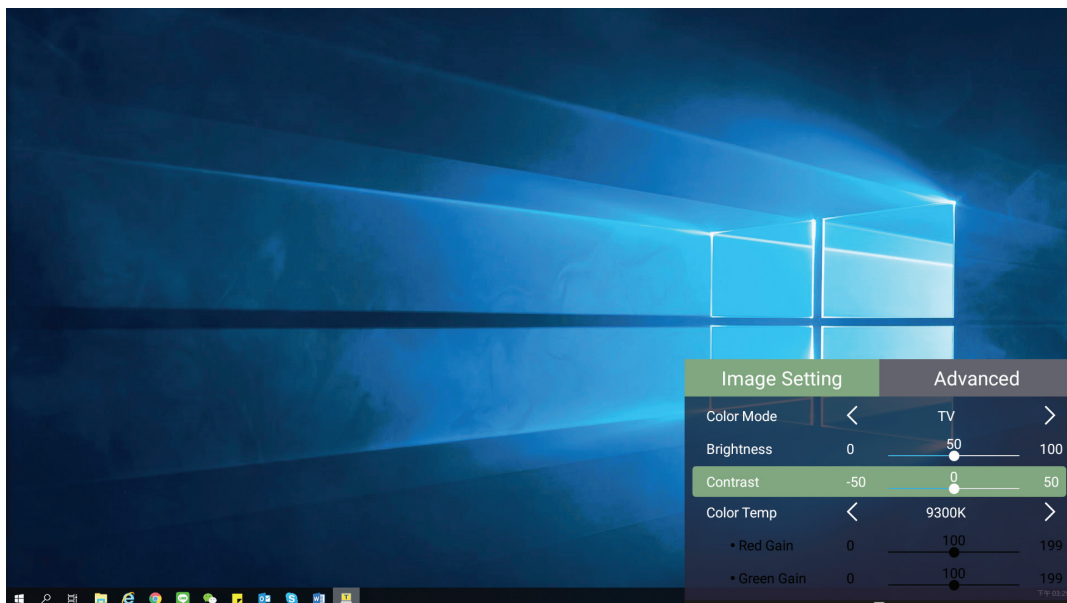

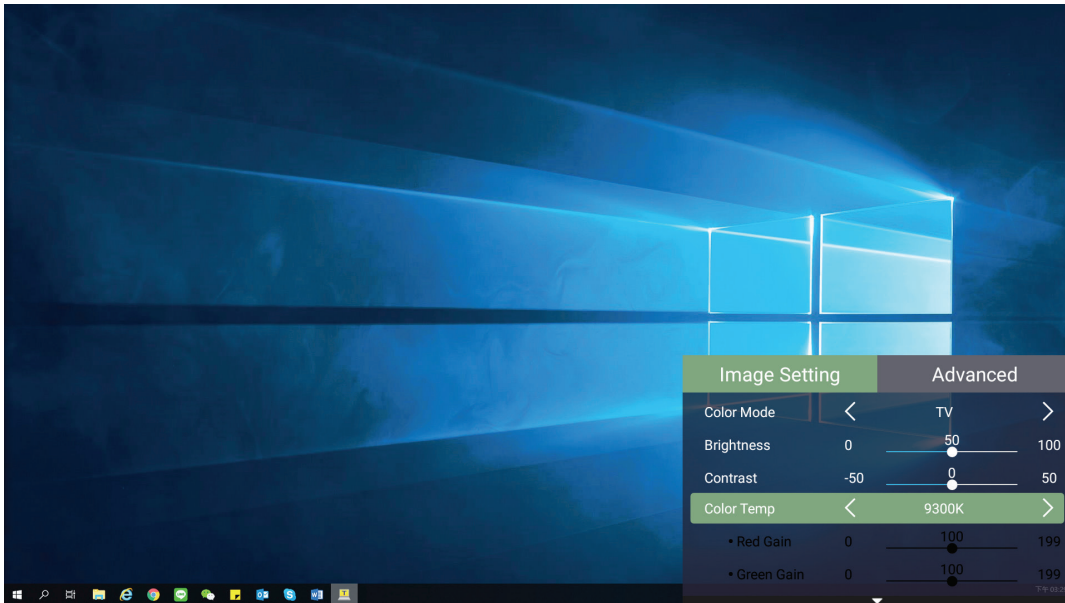



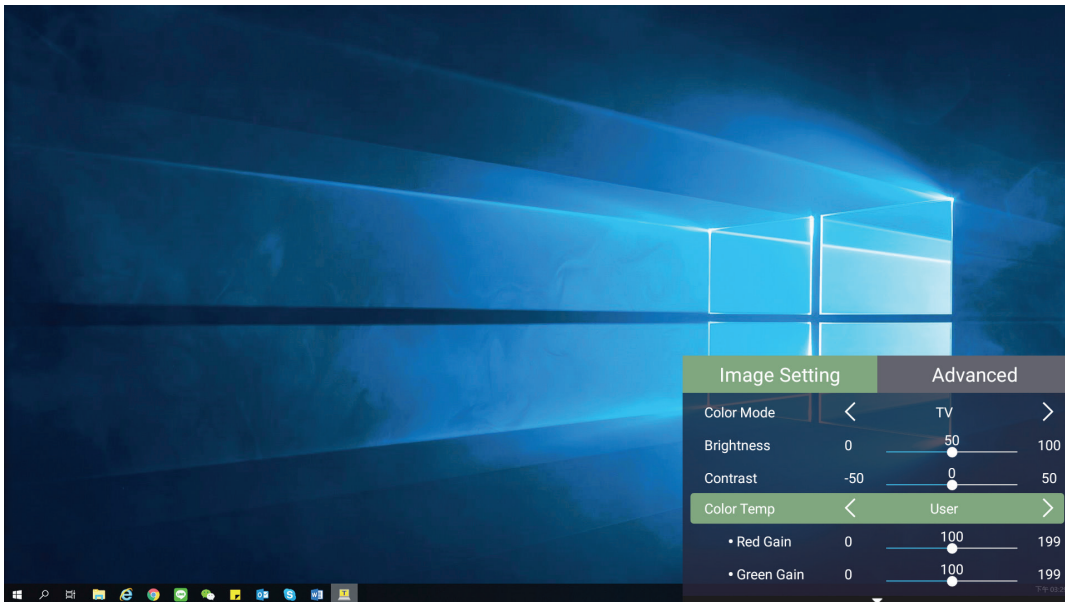



3. Then use the **Left/Right** buttons to enter the sub-menu(s) and/or adjust the settings.



4. Press the **Return** button to go to the previous menu or exit.

Menu Option	Description
Color Mode	<p>The projector is preset with several predefined picture modes so that you can choose one to suit your operating environment and input signal.</p> <p><u>Brightest</u> Maximizes the brightness of the projected image. This mode is suitable for environments where extra-high brightness is required, i.e. well-lit rooms.</p> <p><u>TV</u> Optimized for viewing sports in well-lit environments.</p> <p><u>Gaming</u> Designed for playing video games.</p> <p><u>Movie</u> Appropriate for colorful movies, video clips from digital cameras, or DVs through the PC input. Best for low-light environments.</p> <p><u>User 1/User 2</u> Recalls the customized user settings.</p> <p>NOTE: Only supports HDMI/USB-C signal input.</p>
Brightness	<p>The higher the value, the brighter the image. Lower values will result in a darker image.</p> <div style="display: flex; justify-content: space-around; align-items: center;"> <div style="text-align: center;">  <p>-30</p> </div> <div style="text-align: center;">  <p>50</p> </div> <div style="text-align: center;">  <p>+80</p> </div> </div>
Contrast	<p>Use this to set the peak white level after you have previously adjusted the Brightness setting to suit your selected input and viewing environment.</p> <div style="display: flex; justify-content: space-around; align-items: center;"> <div style="text-align: center;">  <p>-30</p> </div> <div style="text-align: center;">  <p>0</p> </div> <div style="text-align: center;">  <p>+40</p> </div> </div>

Menu Option	Description
Color Temp	Select the color temperature setting. <ul style="list-style-type: none"> • 6500K: Maintains normal white coloring. • 7500K: A higher, cooler color temperature than 6500K. • 9300K: The highest color temperature; makes the image appear the most bluish-white. • User Color: Adjust red, green, and blue values as desired.
Tint	The higher the value, the more greenish the picture becomes. The lower the value, the more reddish the picture becomes.
Saturation	Refers to the amount of that color in a video picture. Lower settings produce less saturated colors; in fact, a setting of “0” removes that color from the image entirely. If the saturation is too high, that color will be overpowering and unrealistic.
Sharpness	A high value results in a sharper picture; a low value softens the picture.
Gamma	Reflects the relationship between input source and picture brightness.

Menu Option	Description
<p>Color Management</p>	<p>Only in permanent installations with controlled lighting levels such as: boardrooms, lecture halls, or home theaters should Color Management be considered.</p> <div data-bbox="676 331 1246 869" data-label="Diagram"> </div> <p>Color Management provides fine color control adjustment to allow for more accurate color reproduction, should you require it.</p> <p>If you have purchased a test disc, which contains various color test patterns and can be used to test the color presentation on monitors, TVs, projectors, etc., you can project any image from the disc on the screen and enter the Color Management menu to make adjustments.</p>
<p>Reset Current Color Settings</p>	<p>Return current color settings to their default values.</p>

Advanced Setting Menu

After your input source is selected, you can adjust the **Advanced** menu.

To access the **Advanced** menu:

1. Press **Setting** on the remote control.

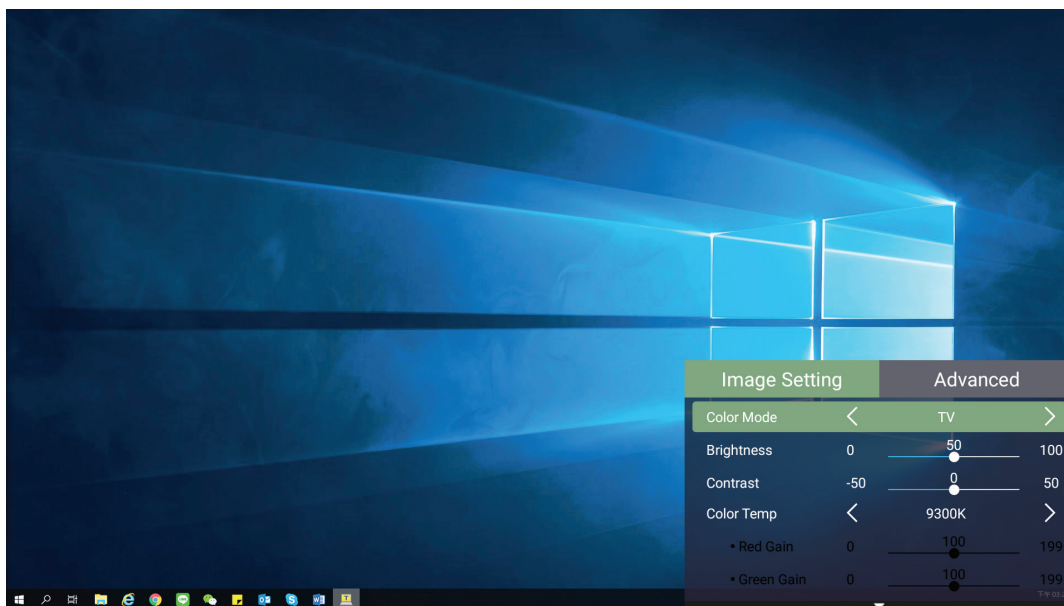

2. Press the **Right** button to access the **Advanced** menu.

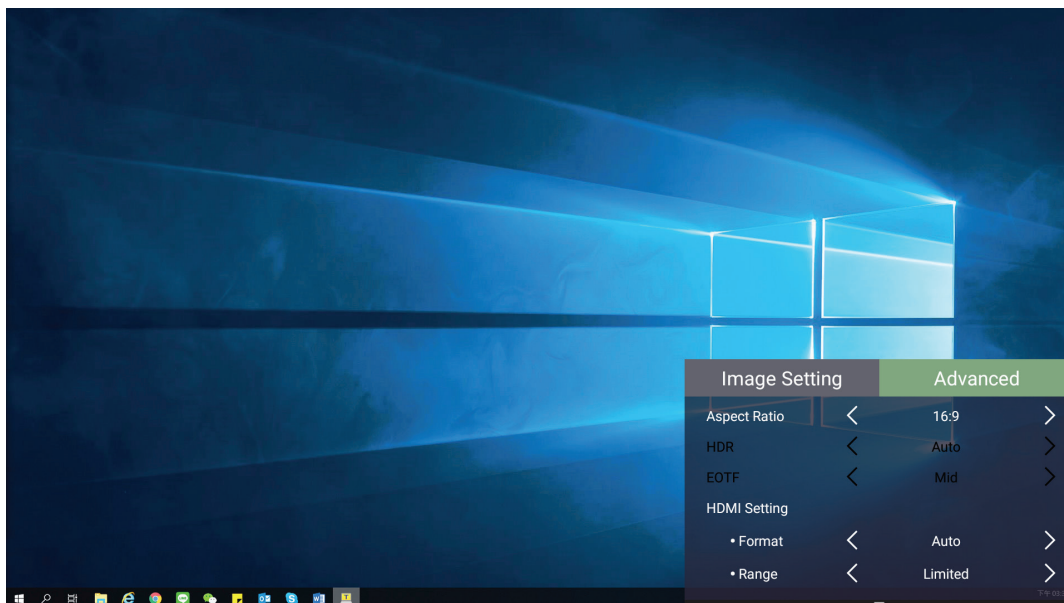

3. Use the **Up/Down** buttons to select a menu.

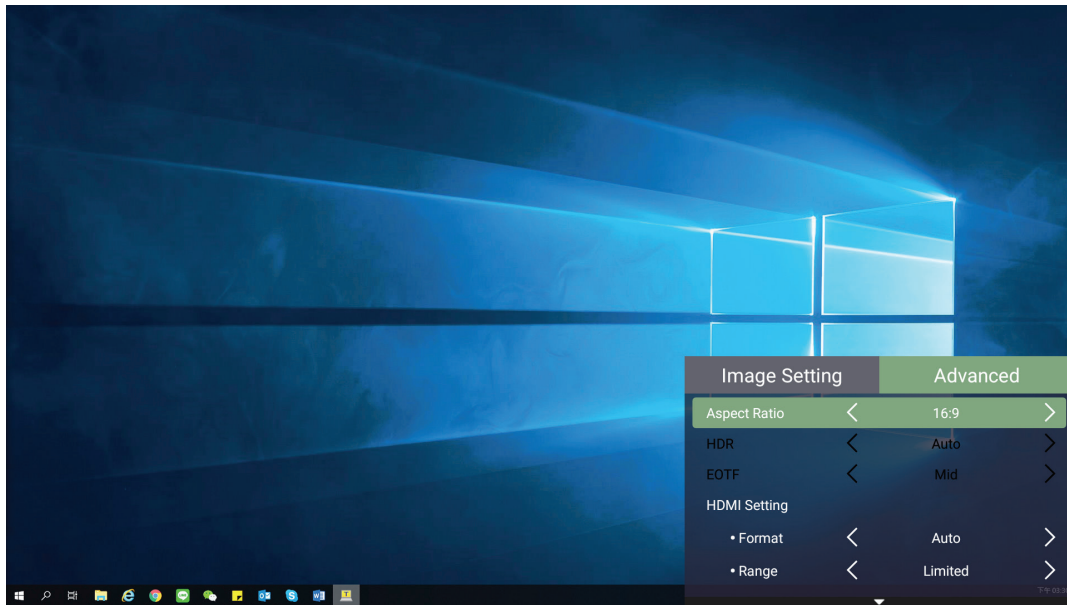

4. Then use the **Left/Right** buttons to enter the sub-menu(s) and/or adjust the settings.

5. Press the **Return** button to go to the previous menu or exit.

Menu Option	Description
Aspect Ratio	<p>The Aspect Ratio is the ratio of the image width to the image height. With the advent of digital signal processing, digital display devices, like this projector, can dynamically stretch and scale the image output to a different aspect than that of the image input signal.</p> <p>NOTE: Only supports HDMI/USB-C signal input.</p> <p><u>Auto</u> Scales an image proportionally to fit the projector's native resolution in its horizontal width. This is suitable for the incoming image which is neither 4:3 nor 16:9 and you want to make the most use of the screen without altering the image's aspect ratio.</p> <p><u>4:3</u> Scales an image so that it is displayed in the center of the screen with a 4:3 aspect ratio. This is most suitable for 4:3 images like computer monitors, standard definition TV, and 4:3 aspect DVD movies, as it displays them without aspect alteration.</p> <p><u>16:9</u> Scales an image so that it is displayed in the center of the screen with a 16:9 aspect ratio. This is most suitable for images which are already in a 16:9 aspect, like high definition TV.</p> <p><u>16:10</u> Scales an image so that it is displayed in the center of the screen with a 16:10 aspect ratio. This is most suitable for images which are already in a 16:10 aspect.</p>

Menu Option	Description
Aspect Ratio	<p><u>2.35:1</u> The image is displayed in the center of the screen with a 2.35:1 aspect ratio.</p> <p><u>Anamorphic</u> Scales a 2.35:1 aspect image so that it fills the screen.</p> <p><u>Native</u> Projects the image as its original resolution and resizes it to fit within the display area. For input signals with lower resolutions, the projected image will be displayed in its original size.</p>
HDR	The projector supports HDR imaging. It can automatically detect the dynamic range of the source from the HDMI port, and optimize settings to reproduce contents under a wide range of light conditions.
EOTF	<p>Automatically adjusts the brightness levels of your image according to the input source. You can also manually select a brightness level to display better picture quality.</p> <p>NOTE: This function is not available when SDR is selected in the HDR menu.</p>
HDMI Settings	<p><u>Range</u> Select a suitable color range according to the color range setting of the connected output device.</p> <ul style="list-style-type: none"> • Full: Sets the color range from 0~255. • Limited: Sets the color range from 15~235. • Auto: Sets the projector to detect the range of the input signal automatically.

Menu Option	Description
3D Settings	<p>Enables you to enjoy 3D movies, videos, and sporting events in a more realistic way by presenting the depth of the images while wearing 3D glasses.</p> <p><u>3D Sync</u> Adjust and choose from: Automatic, Off, Frame Sequential, Frame Packing, Top-Bottom, Side-by-Side.</p> <p><u>3D Sync Invert</u> Allows for correction if the 3D image depth is inverted.</p> <p>NOTE: 3D Settings are available only when H/V Keystone, 4 Corner Adjustment is Off.</p>
harman/kardon	Adjust the audio settings.
Information	Shows Input Source and Resolution.

> Operating the Projector

This section will introduce the **Home Screen** and its menus.

Home Screen

The **Home Screen** is displayed every time you start the projector. To navigate the **Home Screen**, simply use the directional buttons on the remote control. You can return to the main **Home Screen** at any time by pressing the **Home** button on the remote control, regardless of what page you are on.

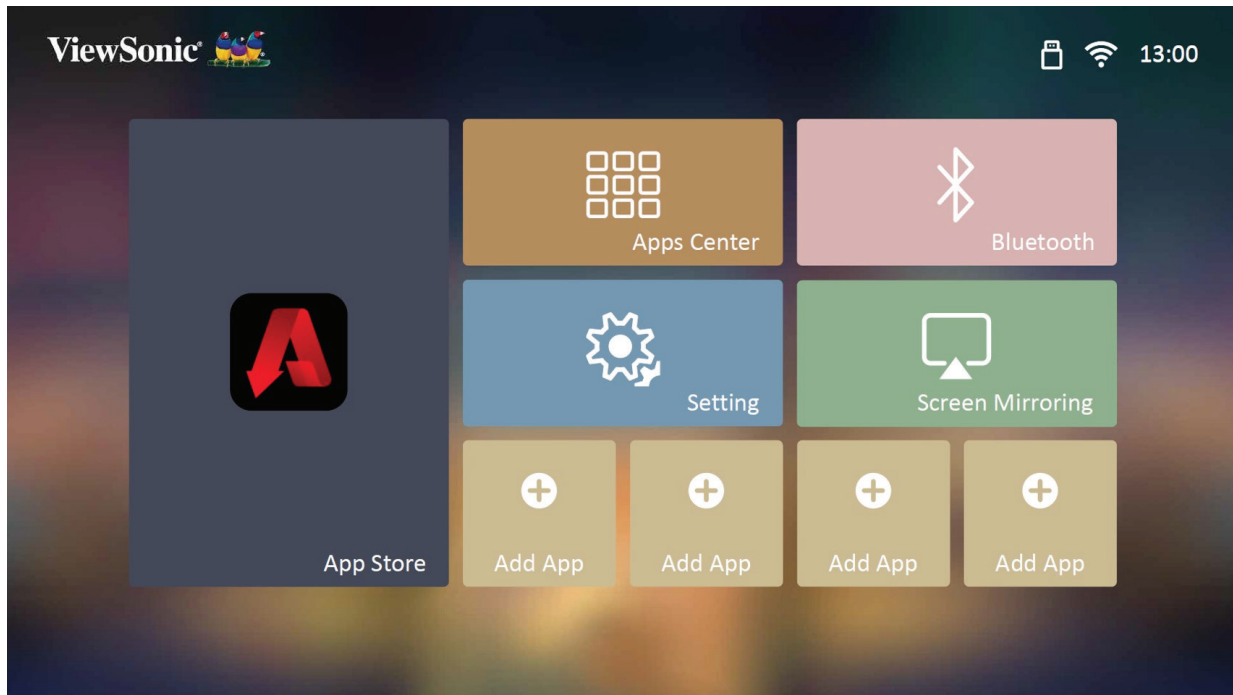

Menu	Description
App Store	Use to download common, popular Apps.
Apps Center	Access and view all the applications you have installed.
File Management	Provides a user interface to manage files and folders.
Setting	Manage various categories such as: Network settings, Basic and Advanced settings, Date & Time, Firmware update, and System Information.
Screen Mirroring	Mirror your personal device's screen through the projector.
Add App	Select your favorite Apps and add them to the Home Screen .

Home Screen - On-Screen Display (OSD) Menu Tree

Main Menu	Sub-menu	Menu Option	
App Store			
Apps Center			
Setting	Network Settings	Wi-Fi	Off
			On
SSID:			
Configure IP			
IP Address			
Subnet Mask			
Default Gateway			
DNS Server			
			Others
Setting	Basic Settings	Language	English
			French
			German
			Italian
			Spanish
			Russian
			繁體中文
			簡體中文
			日本語
			韓語
			Swedish
			Dutch
			Turkish
			Czech
			Portuguese
			Thai
			Polish
			Finnish
			Arabic
			Indonesian
Hindi			
Vietnam			
Greek			

Main Menu	Sub-menu	Menu Option			
Setting	Basic Settings	Projector Projection	Front Table		
			Front Ceiling		
			Rear Table		
			Rear Ceiling		
		Keystone	HV Keystone	On	
				Off	
			Auto V Keystone	On	
				Off	
			V Keystone	(-/+ , -40~40)	
			H Keystone	(-/+ , -34~34)	
			4 Corner	(-/+ , -40~40)	
		Focus	Manual		
			Auto Focus	Off	
				On	
		Bluetooth Device Search	Bluetooth Device Search		
		Eye Protection	Off		
			On		
			Standby Voice Control		
		On			
		Date & Time	Automatic Date & Time	Off	
	On				
	Date				
	Time				
	Time Zone				
	Time Format		12 Hours		
		24 Hours			
	Firmware Update	Software Update Online			
		Software Update by USB			
		OTA Reminder	Off		
			On		
	Software Version				

Main Menu	Sub-menu	Menu Option		
Setting	Advanced Settings	Power On Source	Home	
			HDMI	
			USB-C	
		Power On/Off Ring Tone	Off	
			On	
		Auto Power On	Direct Power On	Disable
				Enable
		Smart Energy	Auto Power Off	Disable
				10 minutes
				20 minutes
				30 minutes
			Sleep Timer	Disable
				30 minutes
				1 hour
				2 hours
				3 hours
				4 hours
				8 hours
			12 hours	
			Power Saving	Enable
		Disable		
		harman/kardon	Audio Mode	Movie
				User
				100Hz
				500Hz
				1500Hz
				5000Hz
			10000Hz	
			Audio Volume	(-/+ , 0~50)
		Mute	Off	
			On	
Light Source Level	Full			
	Eco			

Main Menu	Sub-menu	Menu Option		
Setting	Advanced Settings	High Altitude Mode	Off	
			On	
		Reset Settings	Reset	
			Cancel	
		Reset to Factory Default	Reset	
			Cancel	
	Information	Light Source Hours		
		System Version		
		Memory Information	XX GB of XX GB Used	
		Wi-Fi Mac Address		
		Serial Number		
	File Management			
	Screen Mirroring			
Add App				
Add App				
Add App				
Add App				

Menu Operations

App Store

The projector is pre-loaded with the App Store store, which allows users to download and install different Apps.

1. Select: **Home > App Store.**

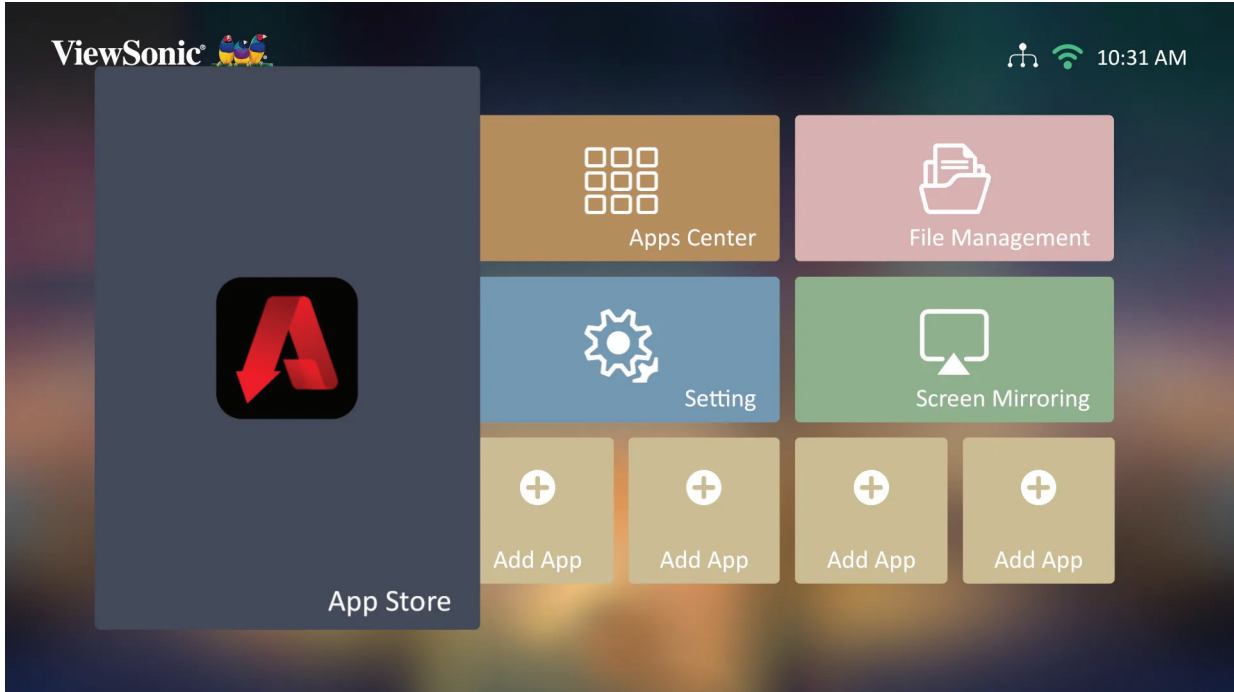

2. Use the direction buttons to navigate the menu options. When you find your preferred App, press the **OK** button to install it.

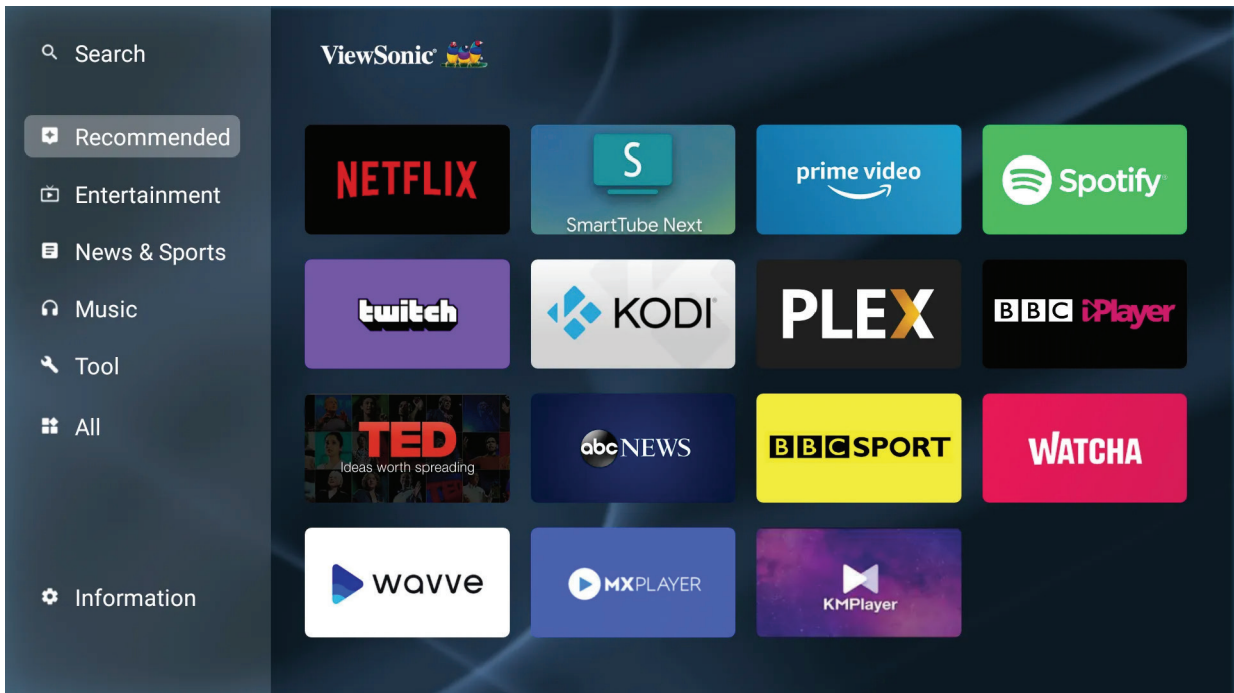

NOTE: Users can install third-party Apps by .apk file in **File Management**. However, some third-party Apps may have compatibility issues.

Apps Center

View, launch, and uninstall Apps.

1. To view your Apps, select: **Home > Apps Center**.

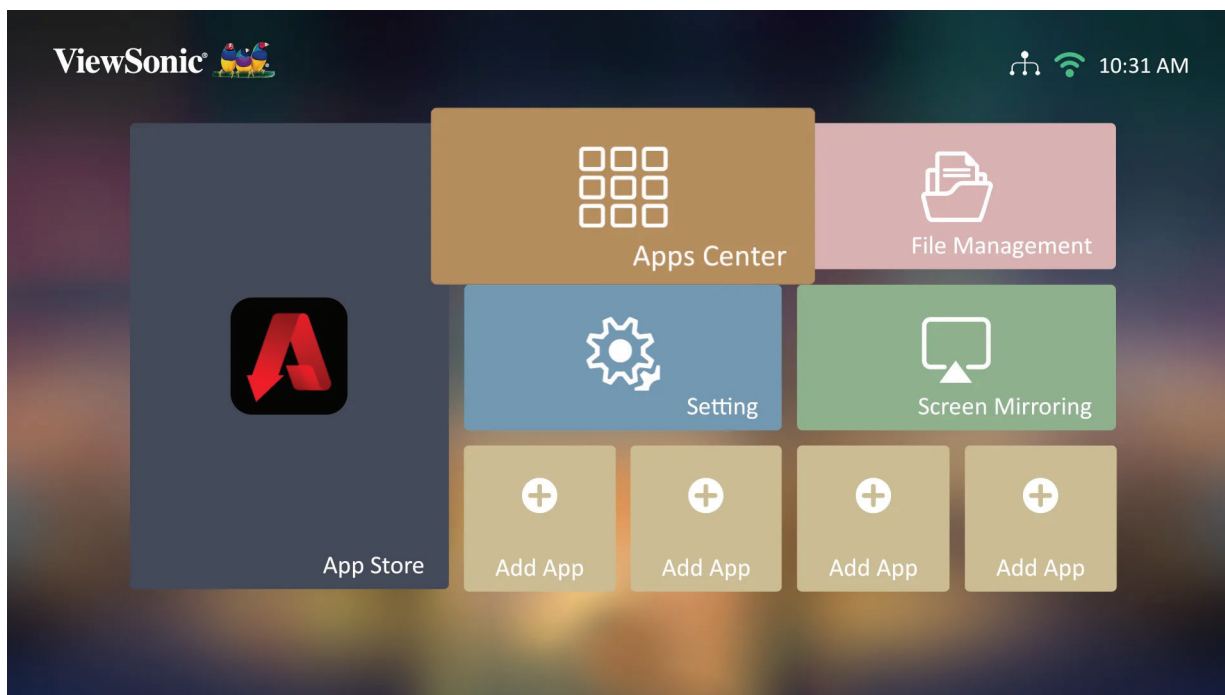

2. Use the direction buttons to select the desired App. Then press **OK** on the remote control to launch the App.

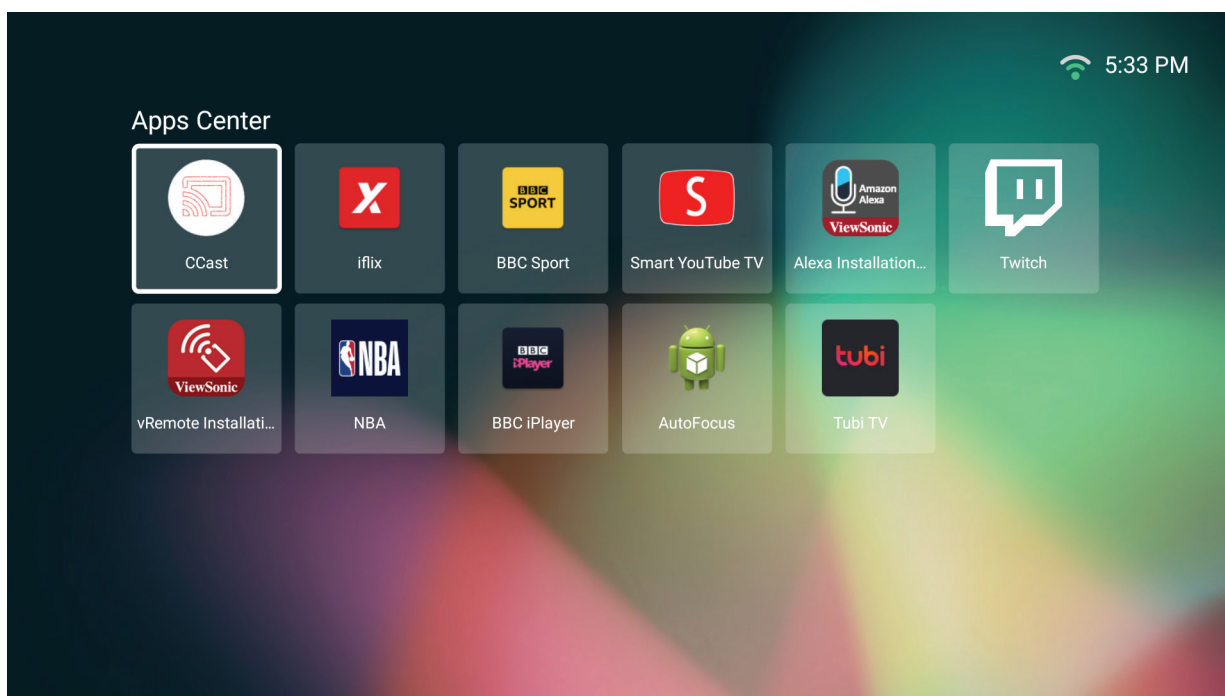

NOTE: Press the **Home** button on the remote control to return to the **Home Screen** at anytime.

To Uninstall Apps

1. Open the **Apps Center** by selecting: **Home > Apps Center**.
2. Use the directional buttons to select the desired App.
3. Press and hold **OK** on the remote control for three (3) seconds. The below dialogue box will appear:

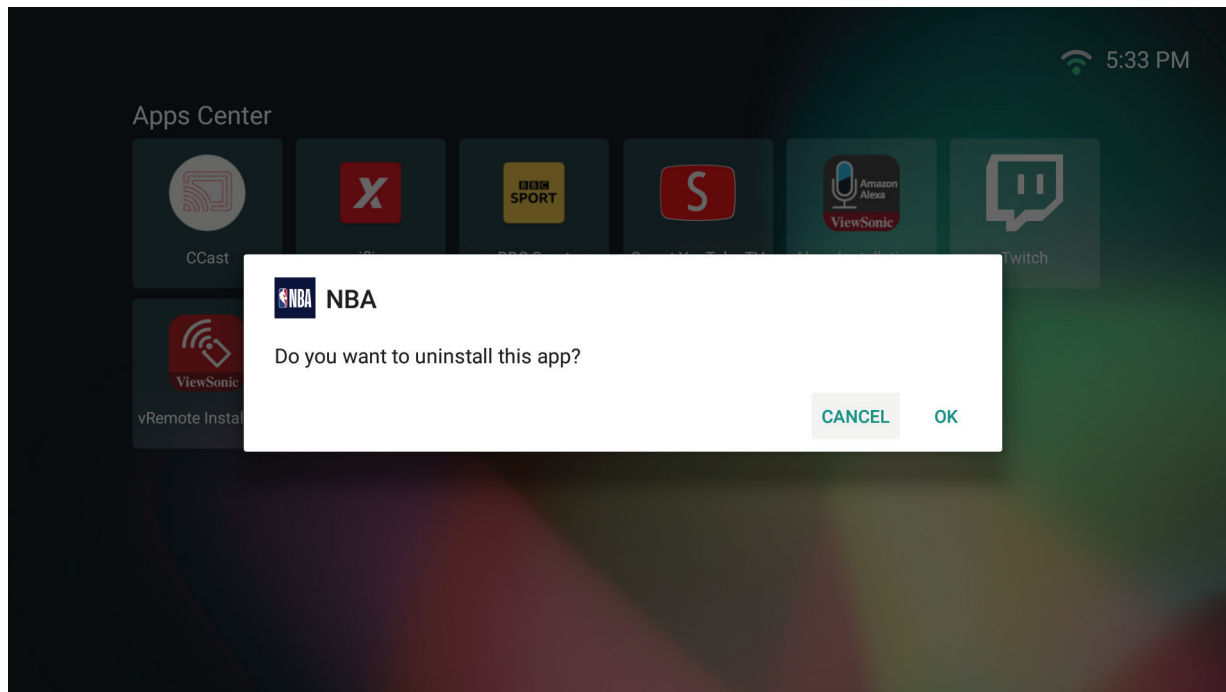

4. Select **OK** to uninstall the App.

NOTE: Press the **Home** button on the remote control to return to the **Home Screen** at anytime.

File Management

Easily manage files and folders.

1. Select: **Home > File Management.**

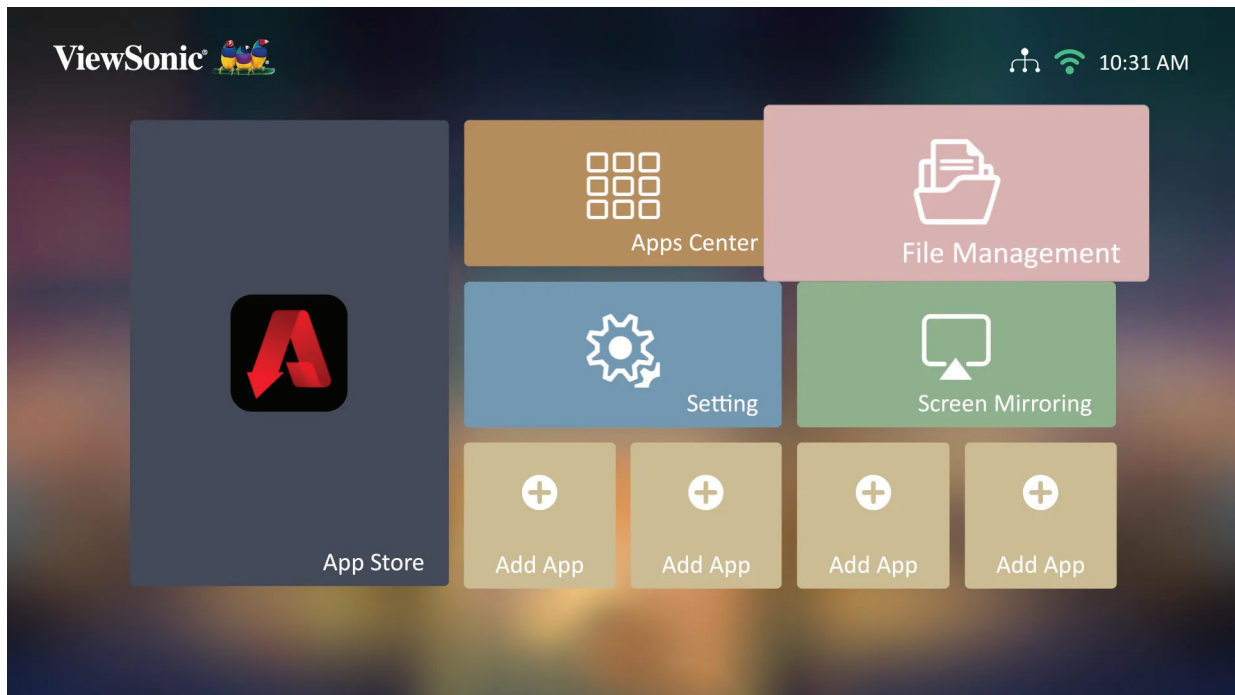

2. Select a device on the source list: USB, Local Storage, etc. Use the direction buttons to select the desired file. Then press **OK** on the remote control to open the selected file.



3. Press the **Return** button to go to a previous a level.

NOTE: Press the **Home** button on the remote control to return to the **Home Screen** at anytime.

How to Edit a File

1. While in **File Management**, press and hold the **OK** button for three (3) seconds.
2. A check box will appear at the front of each file. Use the direction buttons and press **OK** to select one or more files.

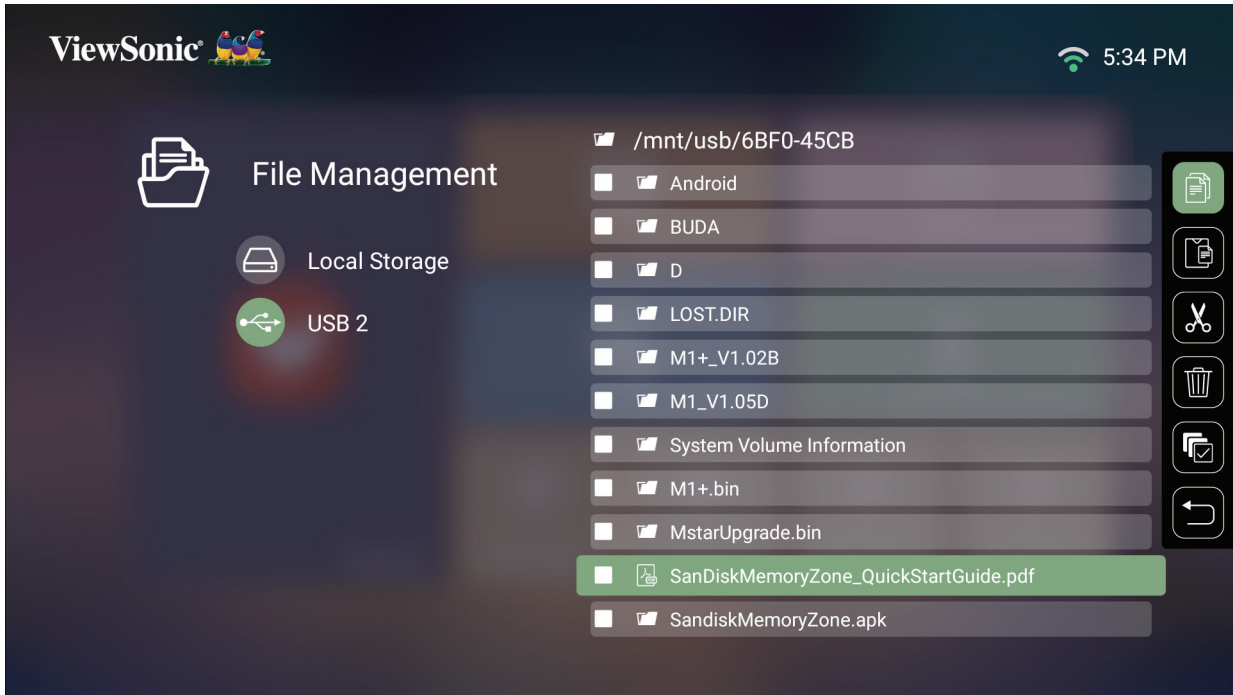



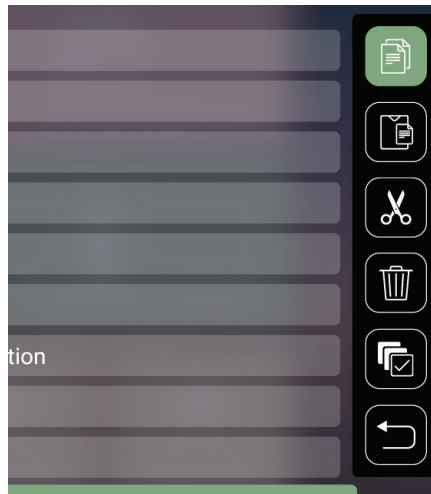



















3. By pressing the **Right** button, Copy, Paste, Cut, Delete, Select All, and Return boxes will be available for use.



4. Select your desired action and press **OK** to execute.
5. If you are Copying or Cutting, select your destination folder to complete the process.

How to Use Control Bar Buttons

The Control Bar buttons will appear on screen if a video, music, or photo file are selected to be opened.

Picture		Video		Music	
	Back		Back		Back
	Play		Rewind		Play
	Next		Play		Pause
	Zoom in		Pause		Next
	Zoom out		Fast Forward		Shuffle
	Rotate (left)		Next		Repeat All
	Rotate (right)		Volume Control		Repeat One
					Play List
					Information

Tips for Using USB

When using USB for reading and/or storage please keep in mind the following:

1. Some USB storage devices may not be compatible.
2. If you use an USB extension cable, the USB device may not recognize the USB.
3. Only use USB storage devices formatted with Windows FAT32 or NTFS file system.
4. Larger files will need extra time to load.
5. Data on USB storage devices may be damaged or lost. Back up important files.

Supported File Formats

Supported Office formats:

	Item	Indicators
Document viewing function	doc/docx	Able to open and read documents in doc/docx
	xls/xlsx	Able to open and read documents in xls/xlsx
	ppt/pptx	Able to open and read documents in ppt/pptx
	Pdf	Able to open and read documents in pdf
Supporting Interface Language	Supporting Interface 44 languages	English, Simplified Chinese, Chinese (TW), Chinese (HK), Spanish (LA), French (EU), PT (EU), PT (BR), German, Russian, Italian, Swedish, Spanish (EU), Korean, Arabic, Farsi, Serbian, Bosnian, Macedonian, Bulgarian, Ukrainian, Greek, Norwegian, Danish, Czech, Hungarian, Slovak, Polish, Romanian, Finnish, Estonian, Latvian, Lithuanian, British English, Slovenian, Croatian, Turkish, Vietnamese, Bahasa Indonesia, Dutch, Malay, Thai, Hindi, Hebrew, Burmese, Catalan.

Supported Multimedia formats:

Extension	Type	Codec
.xvid	Video	Xvid, H.264
.avi	Audio	MP3
.mp4 .m4v .mov	Video	H.264/MPEG 4
.mkv	Video	H.264
.ts	Video	H.264, MPEG2
.trp .tp .mts .m2ts	Audio	MP3
.vob	Video	MPEG1, MPEG2
	Audio	DVD-LPCM
.mpg	Video	MPEG1

NOTE: The AAC audio format is not supported.

Setting

Under **Setting** you can adjust Network, Basic, and Advanced Settings, Date & Time, Firmware Update, and view Information.

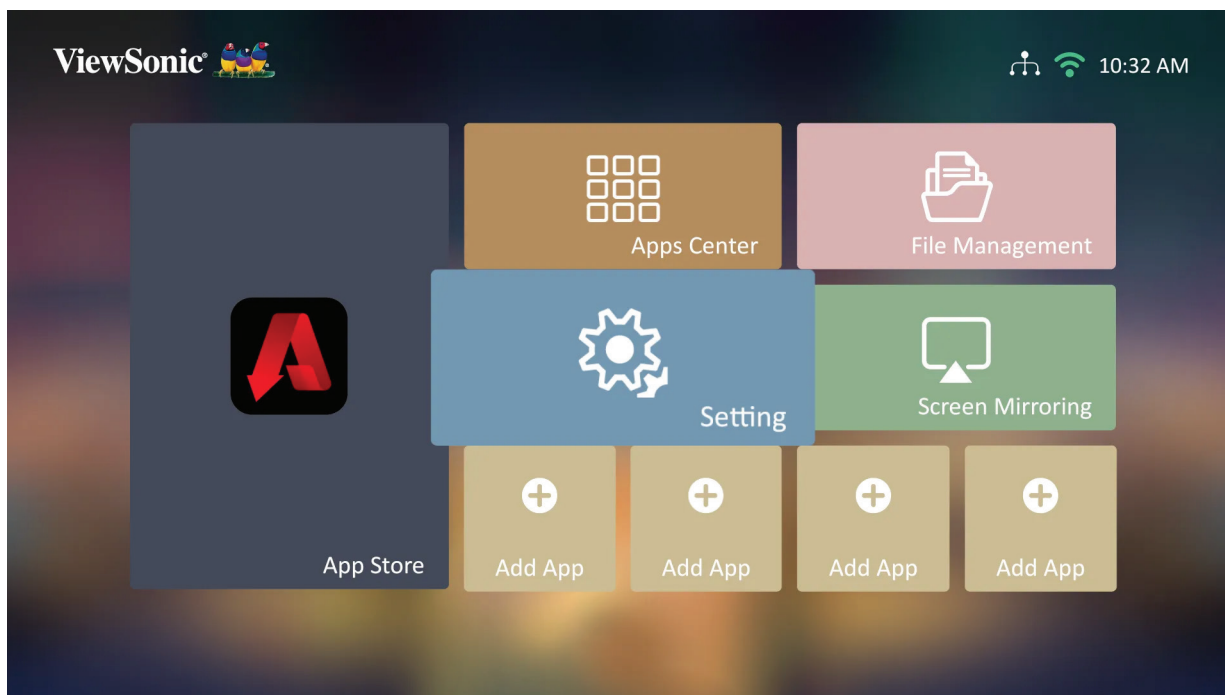

Network Settings

1. Select: **Home > Setting > Network Settings.**

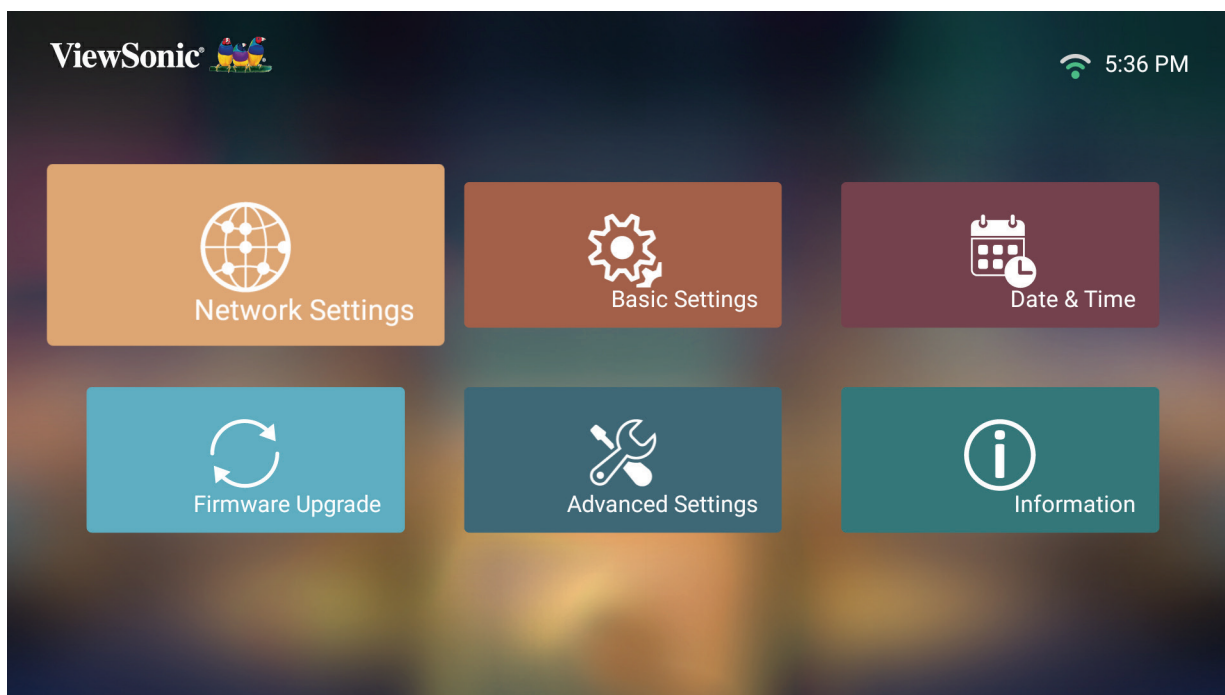

2. View and adjust your Wi-Fi and network settings.



3. To setup a Wireless connection, see “Connecting to Networks” on page 30page 30.

Basic Settings

1. Select: **Home** > **Setting** > **Basic Settings**.

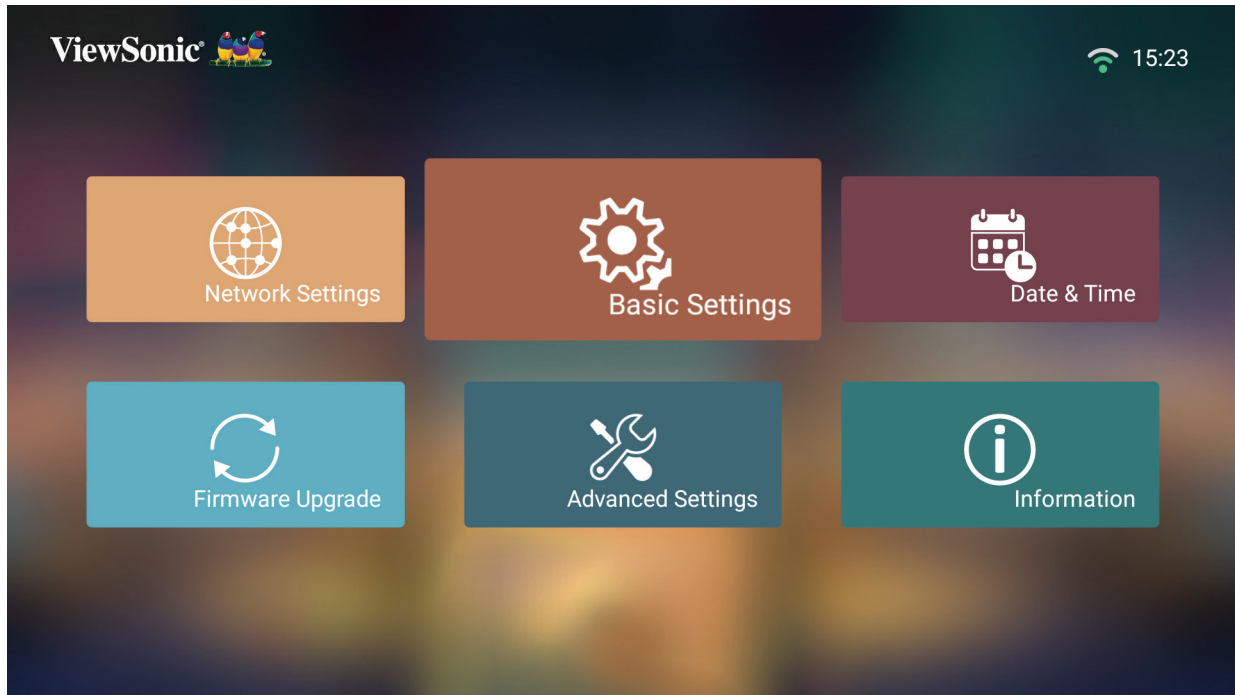

2. Use the **Up** and **Down** buttons to select the desired option and press **OK**, or use the **Left** and **Right** buttons to make adjustments or selections.



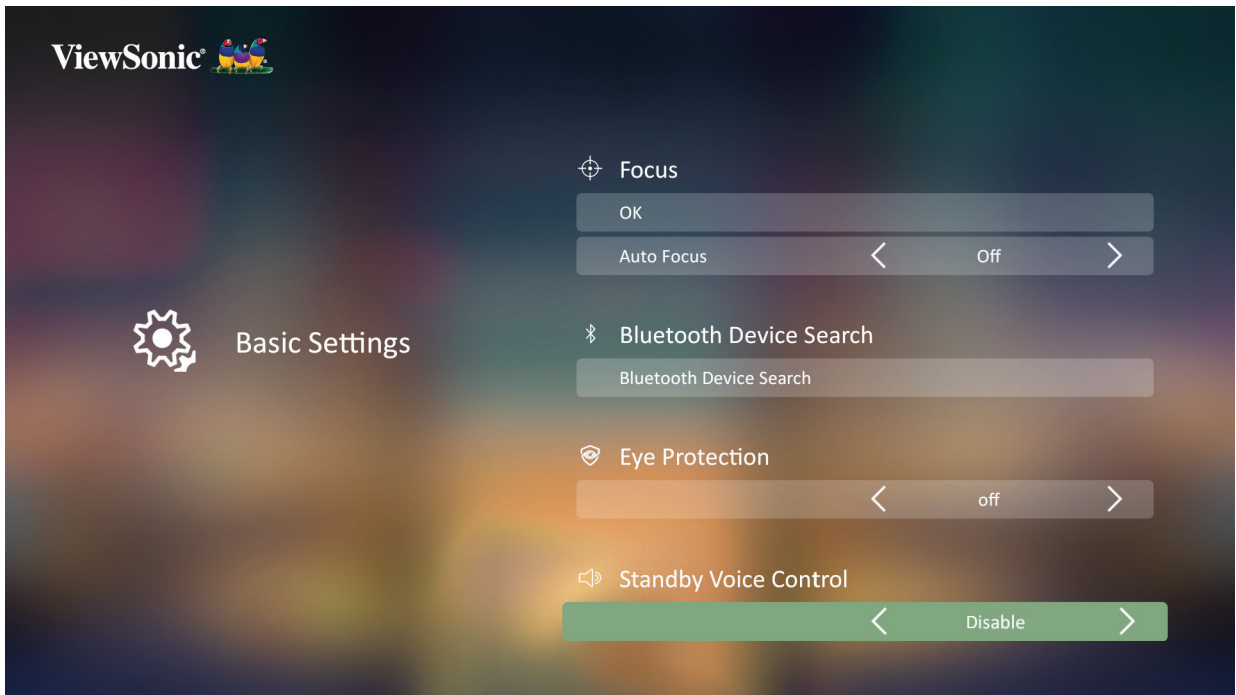

3. To return to a previous menu press the **Return** button.

Menu	Description
Language	Select your desired language.
Projector Position	Select the preferred projection position.

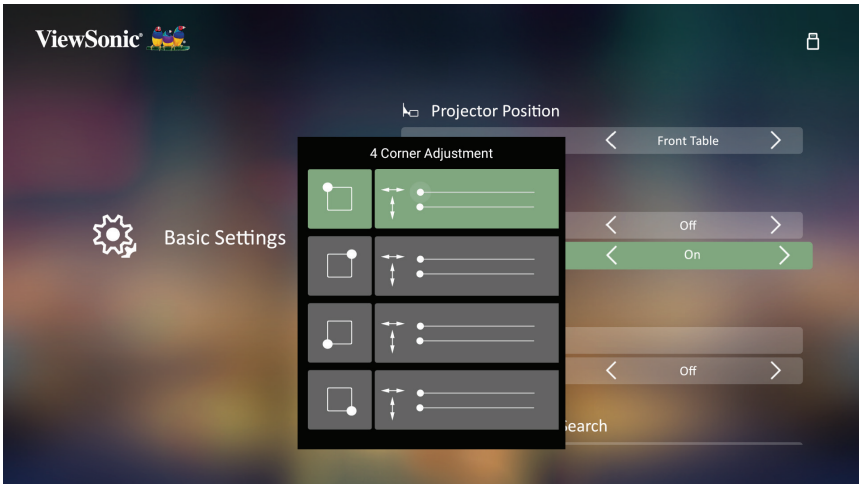
Menu	Description
Keystone	<p>Adjust trapezoidal screen image distortion.</p> <p><u>Auto V Keystone</u> Provides a rectangular screen image by automatically adjusting the keystone number when there is a trapezoidal screen image caused by the tilting of the projector.</p> <ul style="list-style-type: none"> • Enable: Automatically adjust the keystone number. • Disable: Manually adjust the keystone number. <p><u>H/V Keystone</u> Keystone can be adjusted manually.</p> <p><u>4 Corner Adjustment</u> Adjust each corner individually for maximum projection flexibility.</p>  <p>NOTE: 4 Corner Adjustment is available only when H/V Keystone, 3D is Off and not support 4K timing.</p>

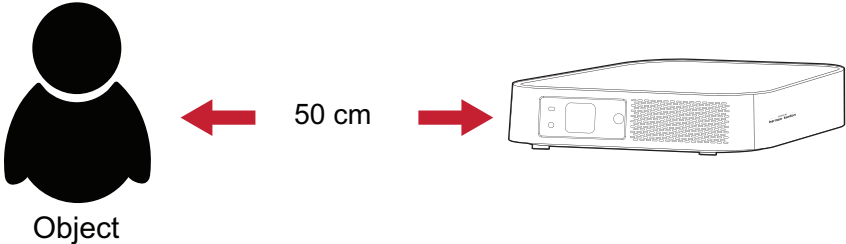
Menu	Description
Focus	<p>Adjust the focus of the screen image.</p> <p>Manual Adjust the focus with the Left and Right buttons on the remote control.</p>  <p>Auto Focus Choose from the following:</p> <ul style="list-style-type: none"> • On: Automatically adjust the focus. • Off: Manually adjust the focus. <p>NOTE: If Auto Focus is On, the projector will automatically focus the screen image when turned on or the position or angle of the projector is adjusted.</p>
Eye Protection	<p>To protect eyes from the direct light of the projector, when an object gets close to the lens, a sensor will detect it and automatically turn off the light.</p> <p>On Turn on the sensor.</p> <p>Off Turn off the sensor.</p> 

Menu	Description
Standby Voice Control	<p>Allows the user to power on the projector with voice control.</p> <p><u>On</u> The projector can be turned on in Standby mode.</p> <p><u>Off</u> The projector cannot be turned on in Standby mode.</p>

Date & Time

Adjust Date, Time, Time Zone, and Time Format.

NOTE: The time is displayed in the top-right corner after connecting to the Internet.

1. Select: **Home > Setting > Date & Time.**

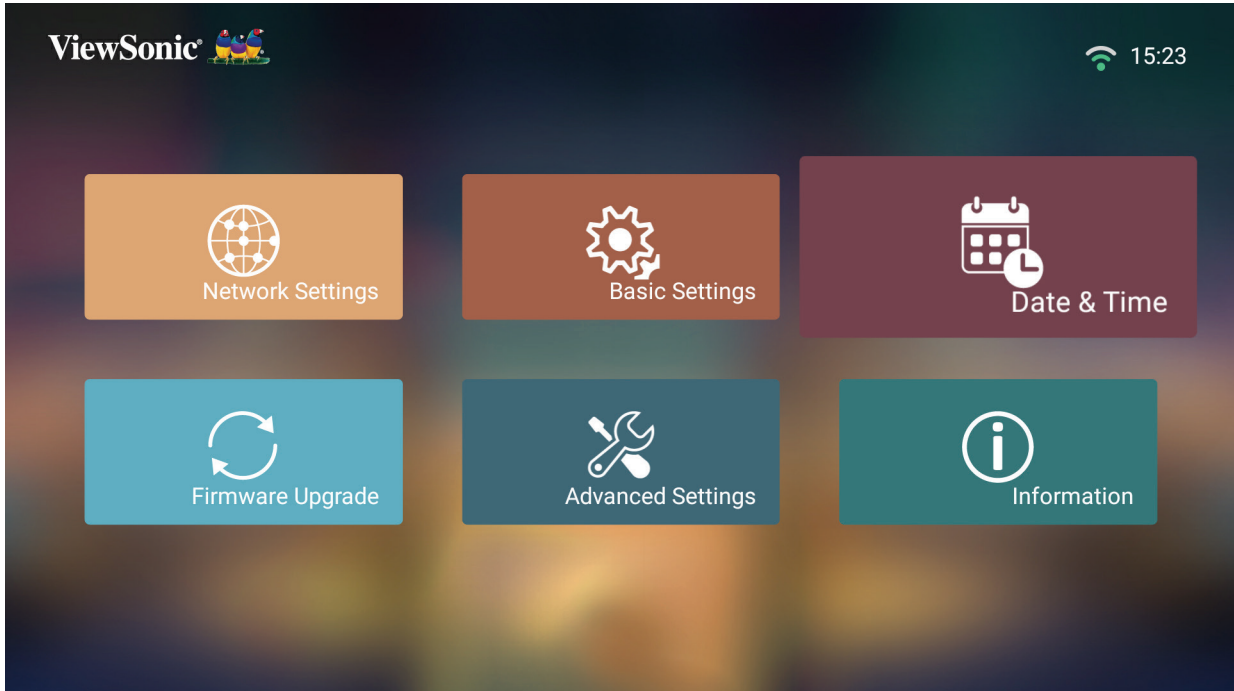

2. Use the **Up** and **Down** buttons to select the desired option and press **OK**, or use the **Left** and **Right** buttons to make adjustments or selections.

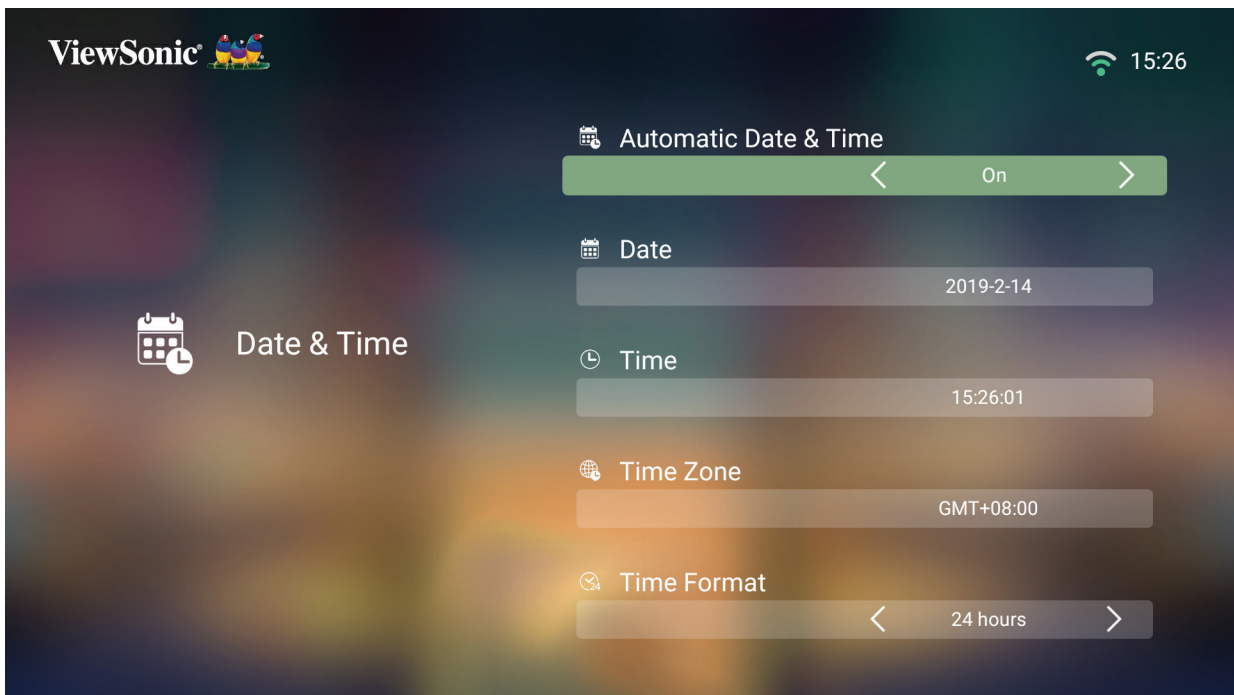

Menu	Description
Automatic Date & Time	Users can synchronize the date and time automatically after connecting to the Internet. <u>On</u> Turn on synchronization. <u>Off</u> Turn off synchronization.
Time Zone	Select your desired location.
Time Format	Select a different display time format. <u>12 Hours</u> 12-hour clock. <u>24 Hours</u> 24-hour clock.

Firmware Upgrade

Users can update the firmware Online, or by USB, and check the version number.

NOTE: Do not unplug the power cord, USB, or disconnect from the Internet during the upgrading process.

1. Before entering the **Firmware Upgrade** menu, ensure the projector is connected to the Internet.
2. To enter the menu, select: **Home > Setting > Firmware Upgrade**.

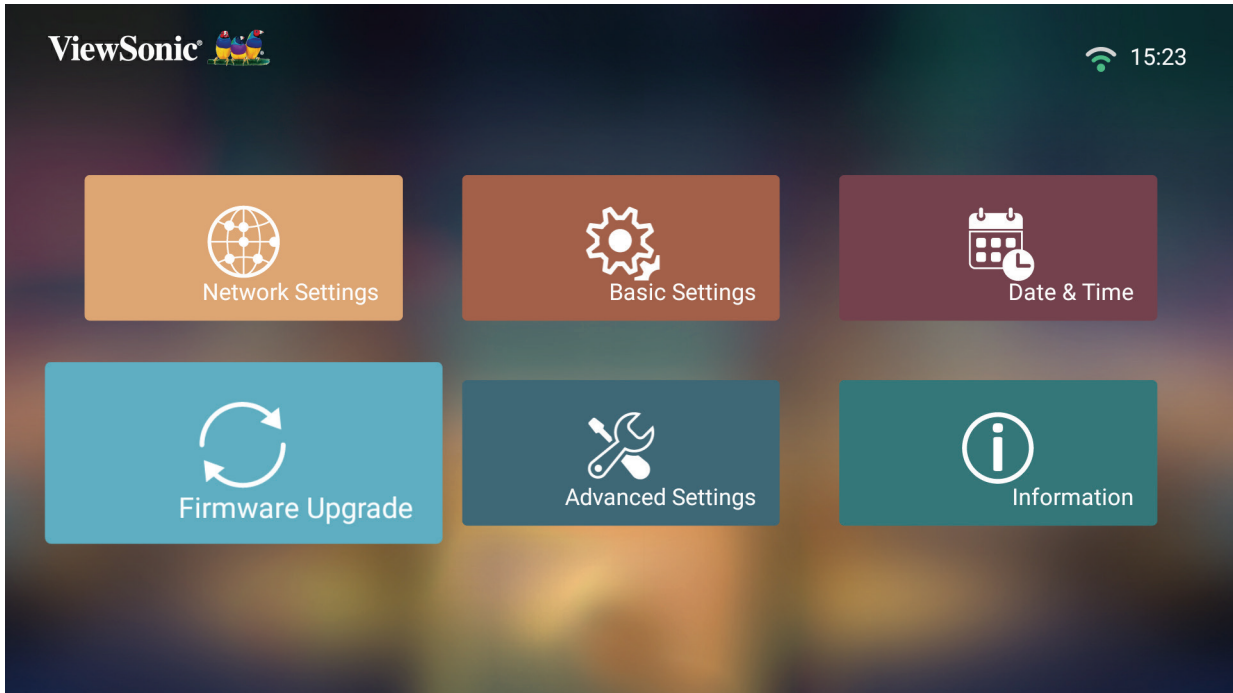

Firmware Update Online

1. Go to: **Home > Setting > Firmware Upgrade > Software Update Online**.



2. Select **Enter** by pressing **OK** on the remote control.
3. The system will check the ViewSonic website (OTA) and display the below dialog message if there is new Firmware.



4. By selecting **Yes**, a progress bar will appear as the update process begins.

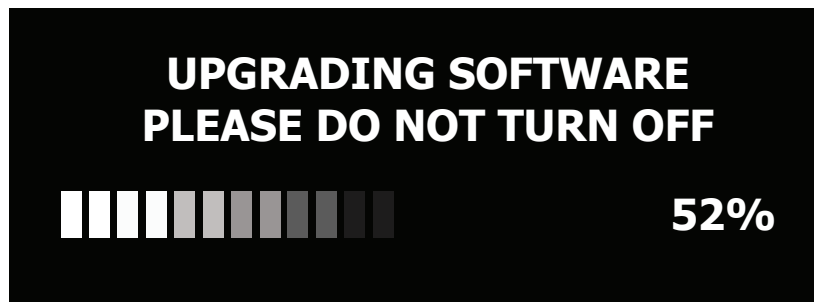

5. Upon reaching 100%, the projector will restart. The whole process will take about 10 minutes.
6. After reaching 100%, the projector will restart and **the screen will turn to black for a few minutes**. The whole updating process will take about 10 minutes.

Firmware Update by USB

1. Download the latest version from the ViewSonic website and copy the file to a USB device.
2. Plug the USB into the projector, then go to: **Home > Setting > Firmware Upgrade > Software Update By USB.**
3. Select **Enter** by pressing **OK** on the remote control.

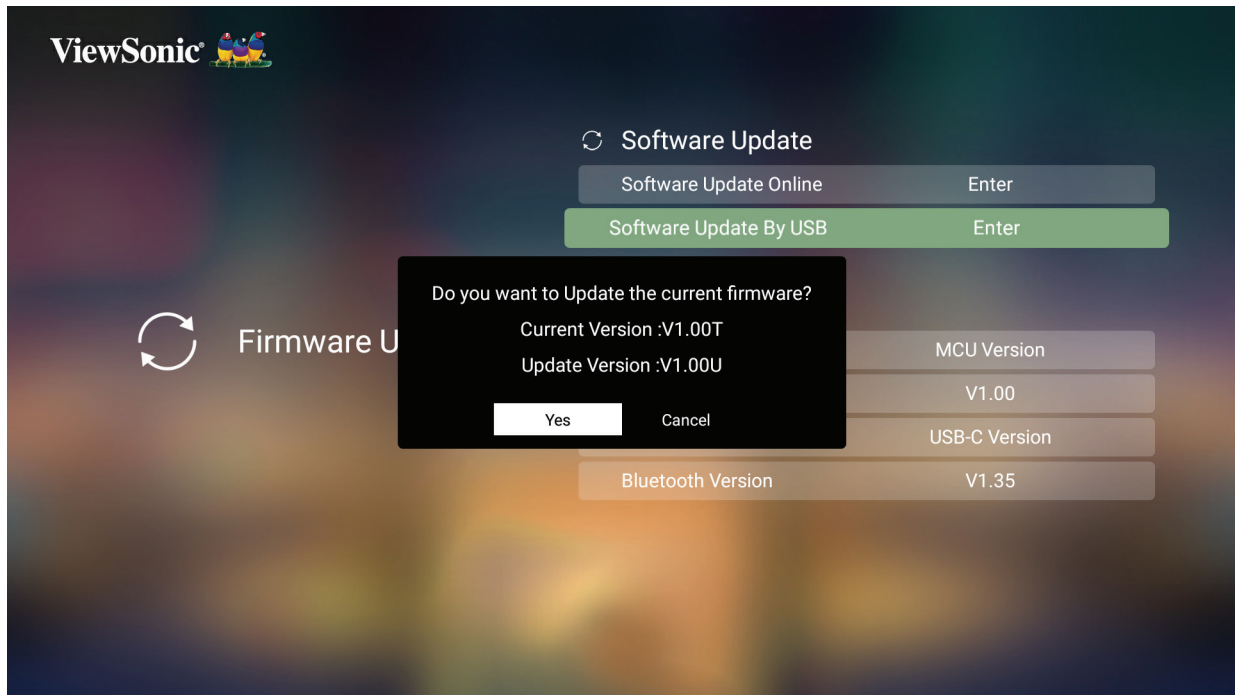

4. The system will detect the Firmware version and display the above dialog message.
5. By selecting **Yes**, a progress bar will appear as the update process begins.
6. After reaching 100%, the projector will restart and **the screen will turn to black for a few minutes**. The whole updating process will take about 10 minutes.
7. After updating the Firmware, it will take a few minutes to restart the projector.

Advanced Settings

1. Select: **Home** > **Setting** > **Advanced Settings**.

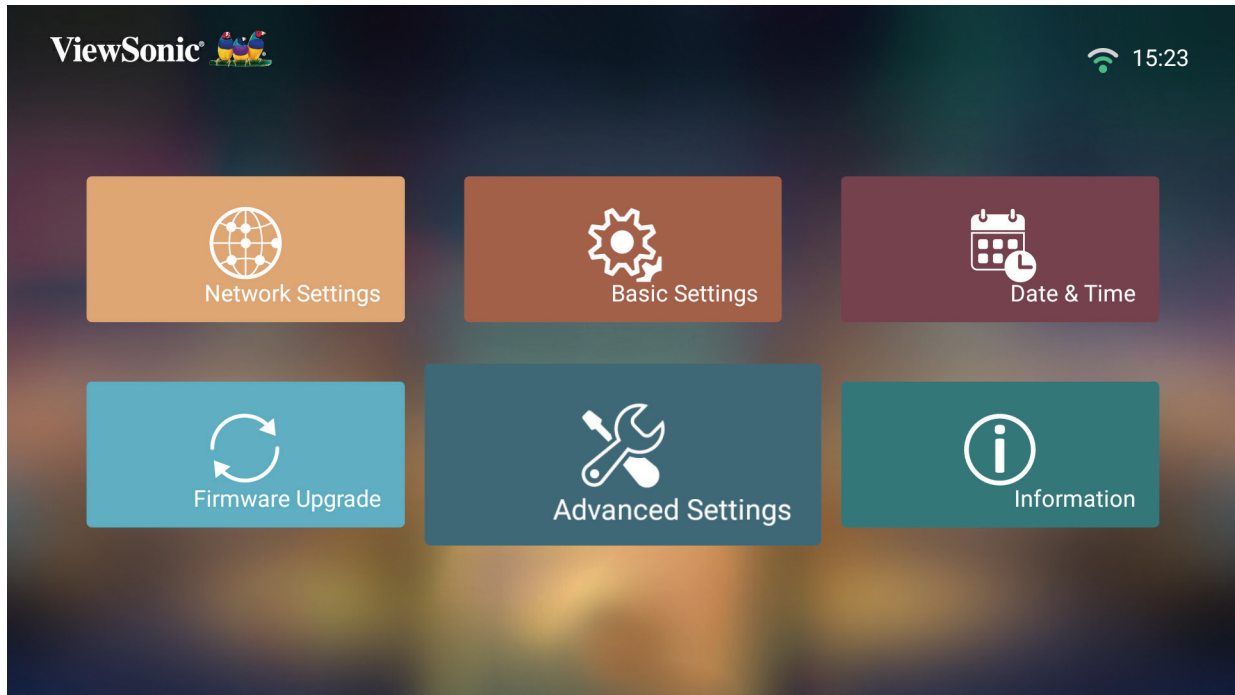

2. Use the **Up** and **Down** buttons to select the desired option and press **OK**, or use the **Left** and **Right** buttons to make adjustments or selections.

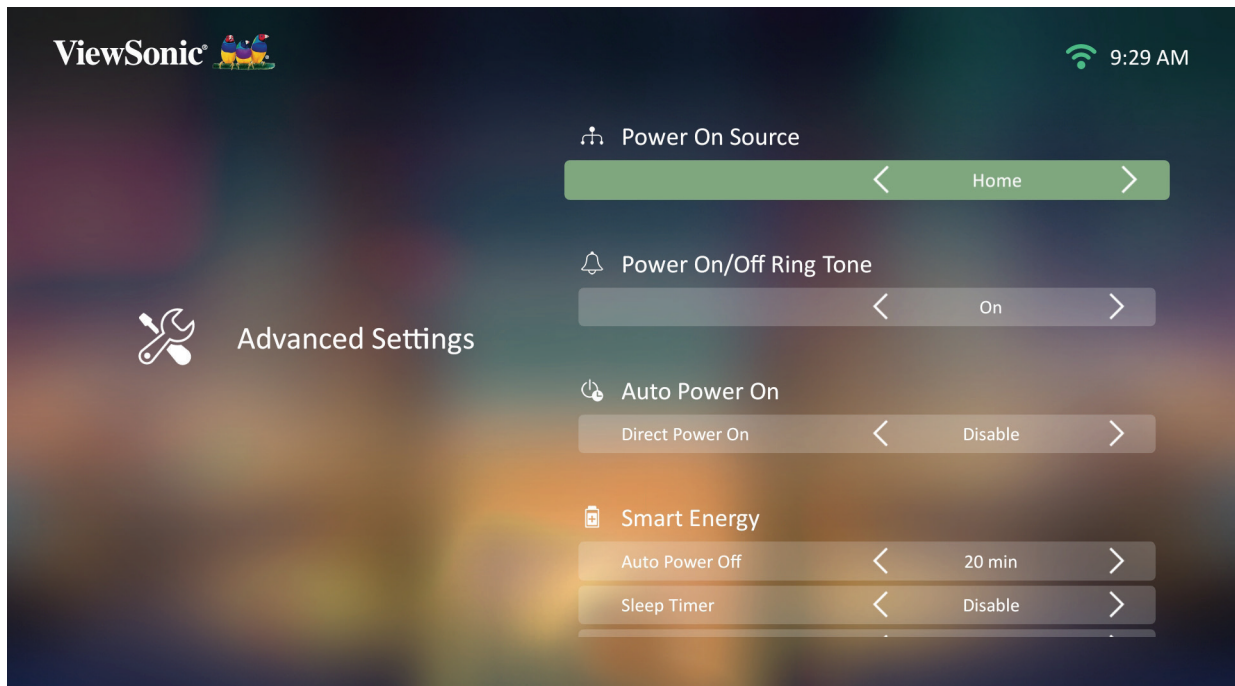

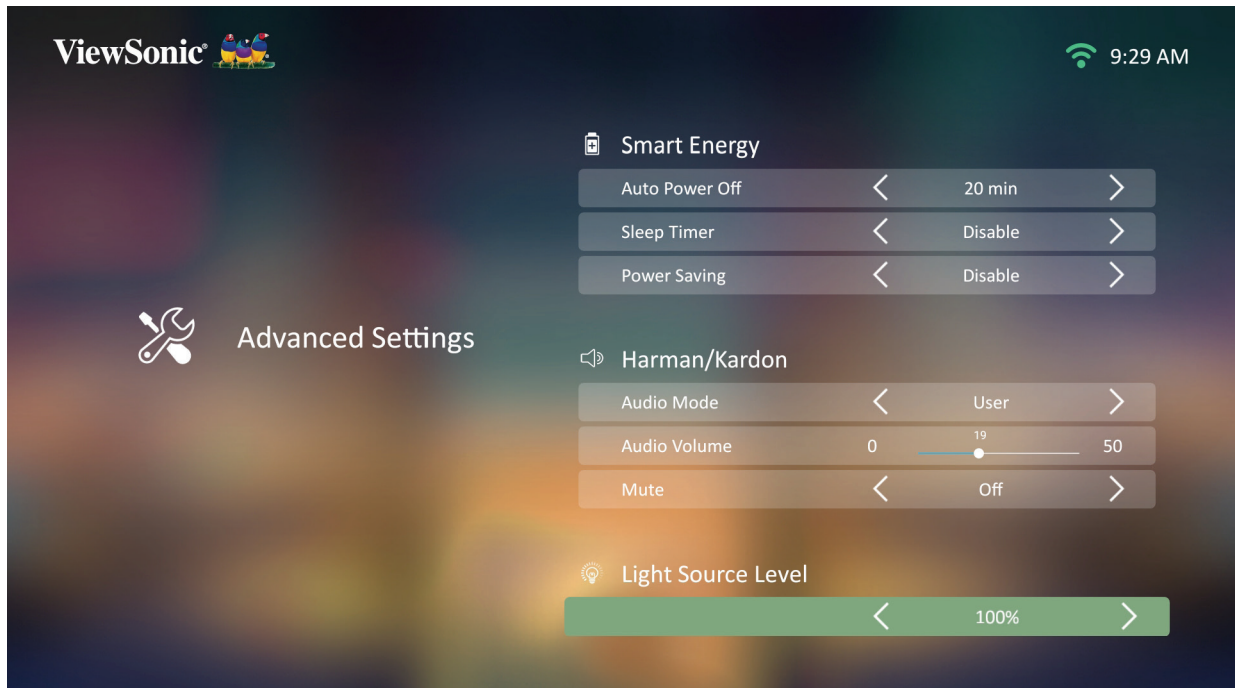

3. To return to a previous menu press the **Return** button.

Menu	Description
Power On Source	Allows the user to enter the desired source directly after turning on the projector.
Power On/Off Ring Tone	Enable or disable the power on/off ring tone.
Auto Power On	<p><u>Direct Power On</u></p> <p>Turn on the projector automatically once plugged into an outlet.</p>
Smart Energy	<p><u>Auto Power Off</u></p> <p>The projector can turn off automatically after a set period of time once no input source is detected.</p> <p><u>Sleep Timer</u></p> <p>Turn off automatically after a set period of time.</p> <p><u>Power Saving</u></p> <p>Lower power consumption if no input source is detected after five (5) minutes.</p> <p>NOTE: The power consumption of the LED will be changed to 30% after no signal is detected for five (5) minutes.</p>

Menu	Description
harman/kardon	<p><u>Audio Mode</u></p> <ul style="list-style-type: none"> • Movie: Default audio mode. • User: Allows the user to customize the audio equalizer. <p>NOTE: In User mode, 100Hz, 500Hz, 1500Hz, 5000Hz, and 10000Hz can be selected.</p>  <p><u>Audio Volume</u> Adjust the volume from 0 to 50.</p> <p><u>Mute</u> Mute or unmute the volume.</p>
Light Source Level	<p>Select the suitable power consumption of the LED.</p> <p><u>Full</u> 100%</p> <p><u>Eco</u> 70%</p> <p>NOTE: If using a USB-C connected power bank to charge the M2, the light source level will only have Full (50%) and Eco (30%) options.</p>

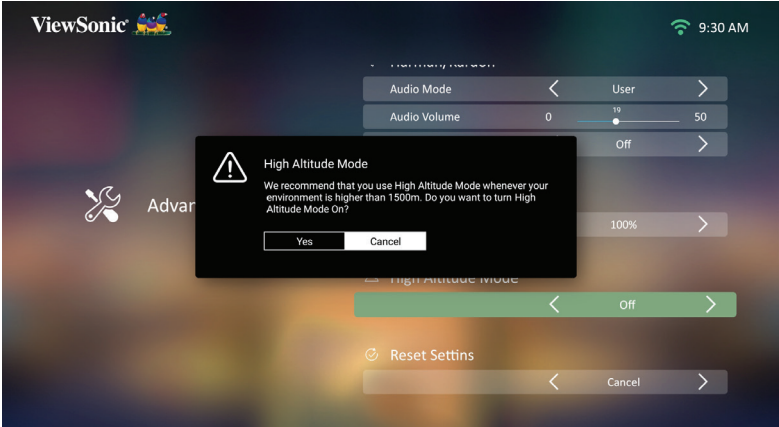
Menu	Description
High Altitude Mode	<p>It is recommended that you use High Altitude Mode when your environment is between 1,500-3,000 m above sea level, and a temperature between 5°C-25°C.</p>  <p>NOTE: If you use this projector under other extreme conditions excluding the above, it may display auto shut-down symptoms, which is designed to protect your projector from over-heating. In cases like this, you should switch to High Altitude Mode to solve these symptoms. However, this is not to state that this projector can operate under any and all harsh or extreme conditions.</p>
Reset Settings	<p>Reset the Settings to default.</p> <p>NOTE: Language, High Altitude Mode, Projector Position, Network Settings, All installed Apps in the Apps Center, Add App, and Light Source Hours will remain unchanged.</p>
Reset to Factory Default	<p>Factory reset.</p> <p>NOTE: Light Source Hours will remain unchanged.</p>

Information

1. Select: **Home** > **Setting** > **Information**.

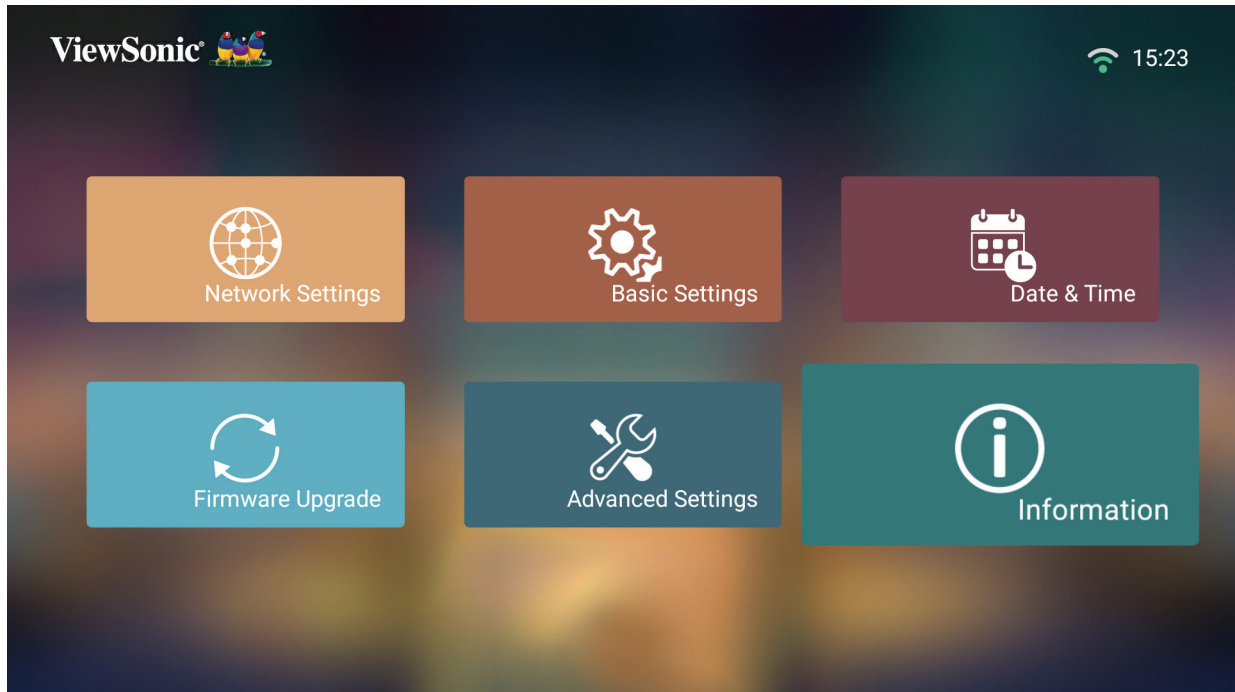

2. View system status and information.



NOTE: Press the **Home** button on the remote control to return to the **Home Screen** at anytime.

Screen Mirroring

Mirror your personal device's screen. To setup wireless Screen Mirroring, see "Wireless Screen Mirroring" on page 23.

NOTE: Ensure your device is connected to the same network as the projector.

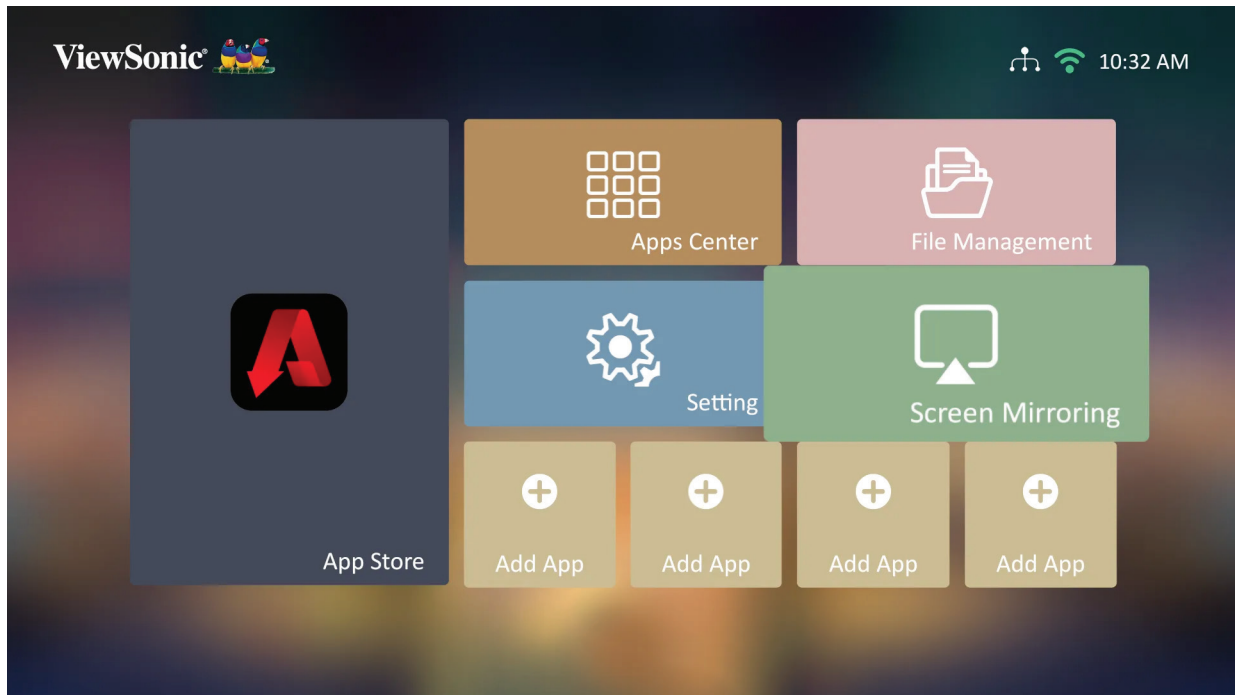

Adding Apps

Add your favorite Apps to the **Home Screen**.

1. From the **Home Screen**, select **Add App** and then press **OK** on the remote control.

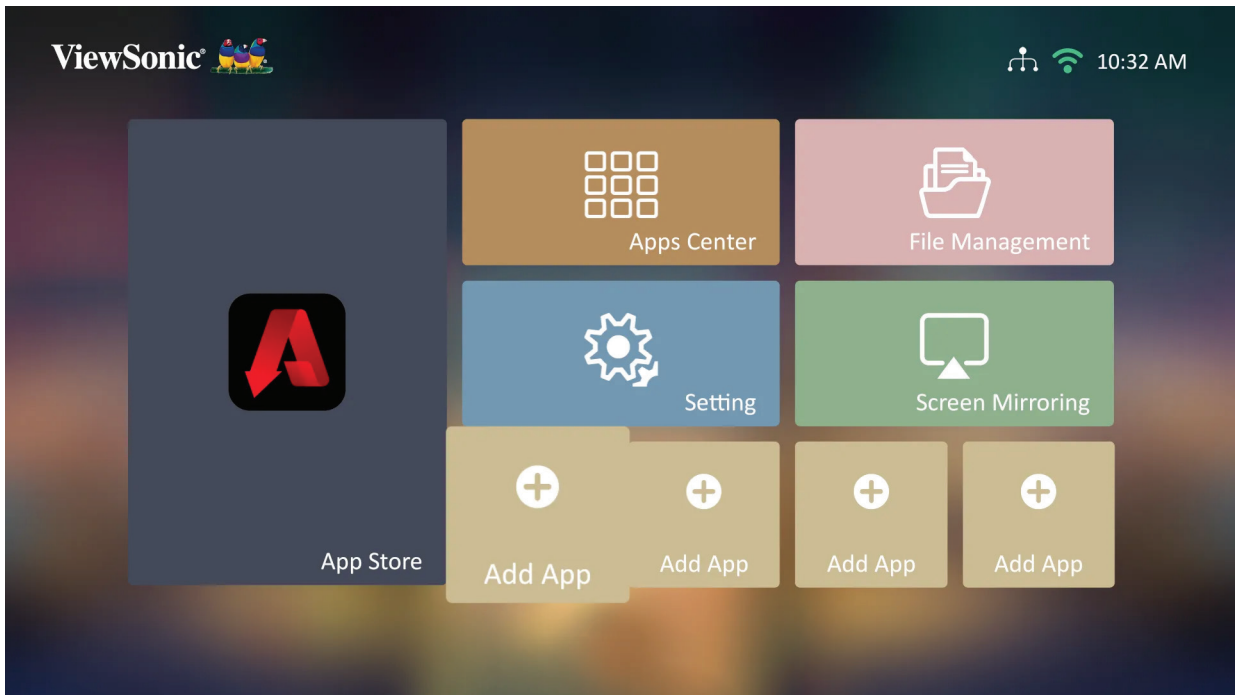

2. Use the directional buttons to select the desired App and press **OK**.

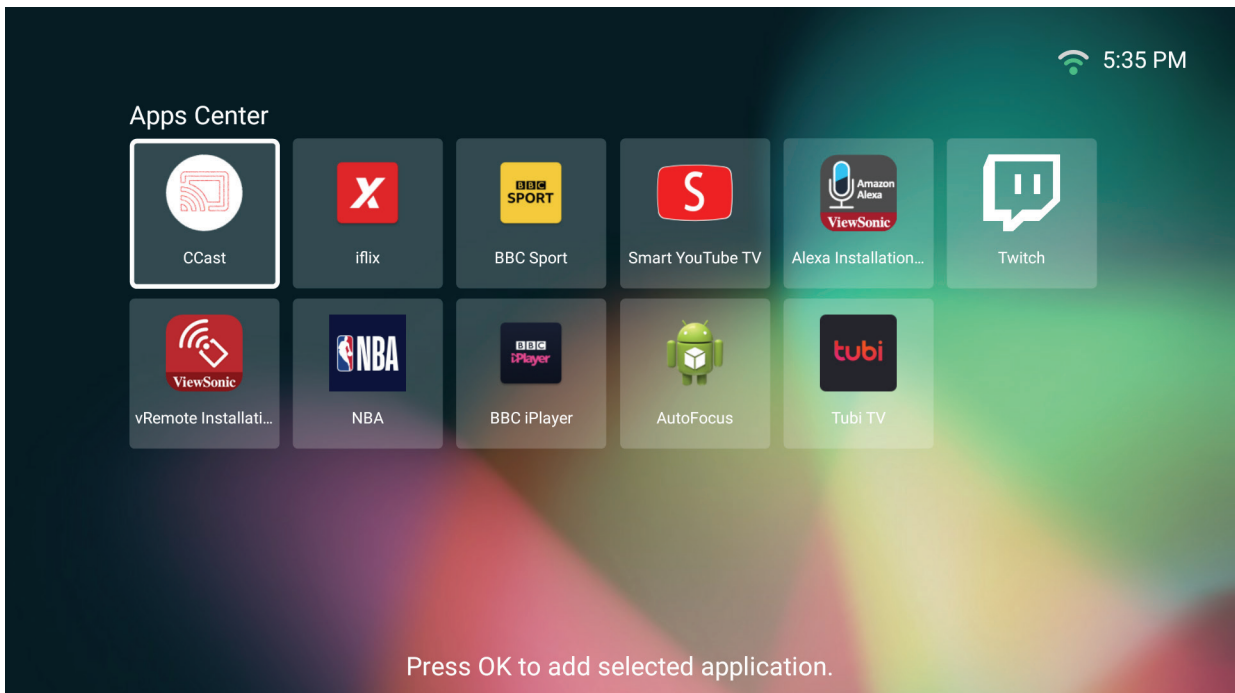

3. Now your favorite App will appear on the **Home Screen**.

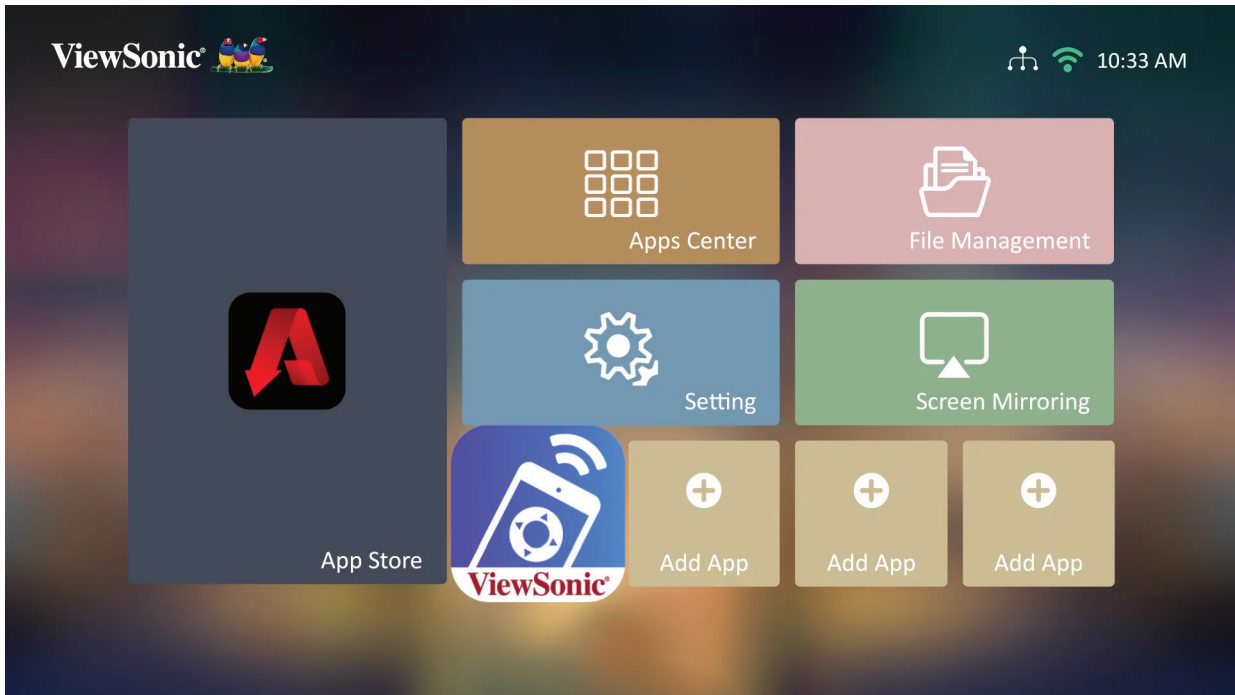

Delete Apps From the Home Screen

1. From the **Home Screen**, select the App you want to delete and press and hold **OK** for three (3) seconds.
2. The message, “Do you want to Delete this application from My Favorites?” will appear.

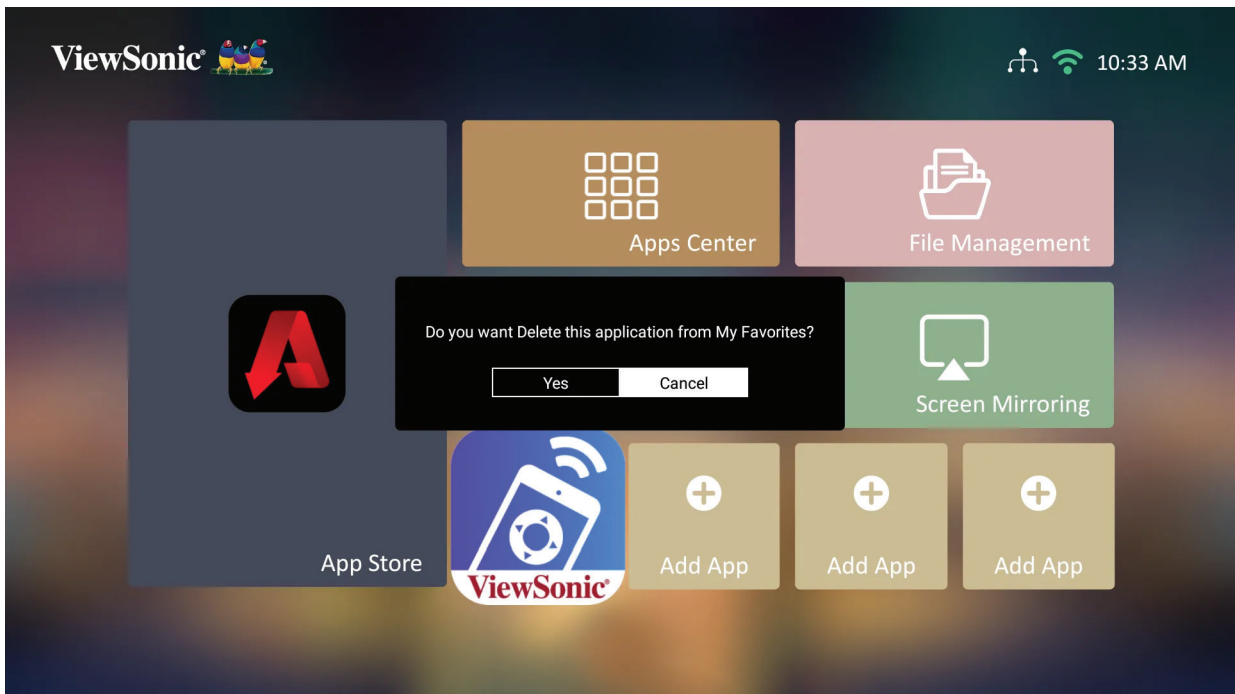

3. Select **Yes**, and press **OK** to delete the App.

> Appendix

Specifications

Item	Category	Specifications
Projector	Type	0.33" 1080p-Full HD, LED
	Display Size	30"~100"
	Brightness	1,200 LED Lumens
	Throw Distance	0.65-2.72 m (80"±3%@2.18 m)
	Lens	F=1.8, f=8.5 mm
	Optical Zoom	Fixed
	Lamp Type	RGBB LED
	Light Source Life (Normal)	up to 30,000 hours
	Display Color	1.07 Billion Colors
	Keystone	-/+ 40 (Vertical & Horizontal)
Input Signal	HDMI	f_h : 30K~97KHz, f_v :24~85Hz,
Resolution	Native	1920 x 1080
	Support	VGA (640 x 480) to 4K (3840 x 2160)
Local Storage	Total	16 GB
	Available	10 GB
Input	HDMI	1 (HDMI 2.0, HDCP 1.4/2.2)
	SD Card	Micro SD (Supports up to 64 GB, SDXC)
	USB Type-C	1 (5V/2A)
	USB Type-A	2 (USB 3.0 Reader x 1; USB 2.0 Reader x 1)
	Wi-Fi Input	1 (5G and 2.4G)
Output	Audio-Out (3.5 mm)	1
	Bluetooth Output	1 (BT 4.0/Audio Out)
	Speaker	3W Cube x 2
	USB Type A (Power)	2 (USB 3.0, 5V/2A; USB 2.0, 5V/1.5A, share with reader)
Power Adapter ¹	Input Voltage	DC IN 100-240V, 50/60 Hz (auto switch)
Operating Conditions	Temperature	0°C to 40°C (32°F to 104°F)
	Humidity	0% to 90% (non-condensing)
Dimensions	Physical (W x H x D)	224.35 x 224.35 x 50.6 mm (8.8" x 8.8" x 1.9")
Weight	Physical	1.3 kg (2.86 lbs)

Item	Category	Specifications
Power Consumption	On	90W (Typical)
	Off	< 0.5W (Standby)

¹ Please use the power adapter from ViewSonic® or an authorized source only.

Projector Dimensions

224.35 mm (W) x 224.35 mm (H) x 50.6 mm(D)

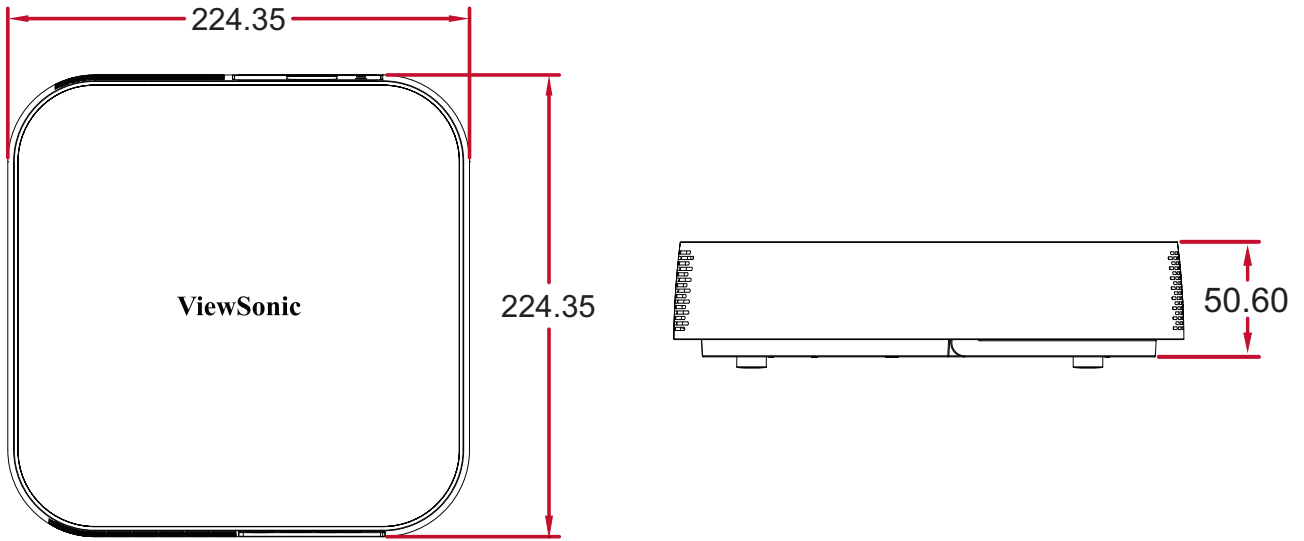

Timing Chart

HDMI Video Timing

Timing	Resolution	Horizontal Frequency (KHz)	Vertical Frequency (Hz)	Dot Clock Frequency (MHz)
480i	720(1440) x 480	15.73	59.94	27
480p	720 x 480	31.47	59.94	27
576i	720(1440) x 576	15.63	50	27
576p	720 x 576	31.25	50	27
720/50p	1280 x 720	37.5	50	74.25
720/60p	1280 x 720	45	60	74.25
1080/50i	1920 x 1080	28.13	50	74.25
1080/60i	1920 x 1080	33.75	60	74.25
1080/24P	1920 x 1080	27	24	74.25
1080/50P	1920 x 1080	56.25	50	148.5
1080/60P	1920 x 1080	67.5	60	148.5

HDMI PC

Resolution	Refresh Rate (Hz)	Horizontal Frequency (KHz)	Dot Clock Frequency (MHz)
640 x 480	59.94	31.469	25.175
	72.809	37.861	31.5
	75	37.5	31.5
	85.008	43.269	36
720 x 400	70.087	31.469	28.3221
800 x 600	60.317	37.879	40
	72.188	48.077	50
	75	46.875	49.5
	85.061	53.674	56.25
	119.854	77.425	83
1024 x 576	60	35.82	46.966
1024 x 600	64.995	41.467	51.419
1024 x 768	60.004	48.363	65
	70.069	56.476	75
	75.029	60.023	78.75
	84.997	68.667	94.5
	119.989	97.441	115.5
1152 x 864	75	67.5	108
1280 x 720	60	45	74.25
1280 x 768	59.87	47.776	79.5
1280 x 800	59.81	49.702	83.5
	74.934	62.795	106.5
	84.88	71.554	122.5
1280 x 960	60	60	108
	85.002	85.938	148.5
1280 x 1024	60.02	63.981	108
	75.025	79.976	135
	85.024	91.146	157.5
1360 x 768	60.015	47.712	85.5
1400 x 1050	59.978	65.317	121.75
1440 x 900	59.887	55.935	106.5
1600 x 1200	60	75	162
1680 x 1050	59.954	65.29	146.25
1920 x 1080 (VESA)	60	67.5	148.5

Resolution	Refresh Rate (Hz)	Horizontal Frequency (KHz)	Dot Clock Frequency (MHz)
640 x 480 @ 67Hz	66.667	35	30.24
832 x 624 @ 75Hz	74.546	49.722	57.28
1024 x 768 @ 75Hz	75.02	60.241	80
1152 x 870 @ 75Hz	75.06	68.68	100

IR Control Table

Function	Address		Code	Inverse
	Byte 1	Byte 2	Byte 3	Byte 4
Power On/Off	83	F4	17	E8
Home	83	F4	16	E9
Focus	83	F4	92	6D
Source	83	F4	40	BF
Setting	83	F4	30	CF
Up	83	F4	0B	F4
Down	83	F4	0C	F3
Left	83	F4	0E	F1
Right	83	F4	0F	F0
OK	83	F4	15	EA
Bluetooth	83	F4	A2	5D
Return	83	F4	28	D7
Mute	83	F4	14	EB
Volume +	83	F4	82	7D
Volume -	83	F4	83	7C
Audio Mode	83	F4	9E	61

Glossary

This section describes the standard glossary of terms used in all projector models. All terms are listed in alphabetical order.

NOTE: Some terms may not be applicable to your projector.

A Aspect Ratio

Refers to the ratio of the image width to the image height.

B Brightest Mode

Maximizes the brightness of the projected image. This mode is ideal for environments where extra-high brightness is required, such as using the projector in well lit rooms.

Brightness

Adjusts brightness levels of the screen image

C CEC (Consumer Electronics Control)

Synchronizes power on/off operation via HDMI connection. That is, if a device that also supports CEC function is connected to the HDMI input of the projector, when the projector's power is turned off, the power of the connected device will also be turned off automatically. When the power of the connected device is turned on, the projector's power will be turned on automatically.

Color

Adjusts the color saturation.

Color Temp

Allows users to select specific color temperature settings to further customize their viewing experience.

Contrast

Adjusts the difference between the image background (black level) and the foreground (white level).

F Focus
Manually improve the clarity of the projected image.

G Gamma
Allows the user to manually select the greyscale curve of the projector.

H HDMI Range
Allows the user to select HDMI greyscale range between 0~255 (full range) , 16~235 (limited range) or Auto by the signal type detected.

HDR (High-Dynamic Range)

Keeps the brightness level and enhances details on the dark level.

High Altitude Mode

Optional mode for users who live in an environment between 1,500 m and 3,000 m above sea level, and the temperature is between 5° C and 25° C. Activating it will improve projector cooling and performance.

I Information
Displays the timing mode (video signal input), the projector model number, the serial number, and the ViewSonic® website URL.

Input Select

Toggles between the various input options that are available for the projector.

K Keystone
The distortion of an image caused by projecting it onto an angled surface.

L Light Source Level

Use Normal or Eco mode to adjust the brightness level and power consumption.

M Movie Mode

A Picture Mode appropriate for playing colorful movies, video clips from digital cameras, or DVs through the PC input. Best for a low light environment.

S Sharpness

Adjusts the picture quality.

Troubleshooting

This section describes some common problems that you may experience when using the projector.

Problem or Issue	Possible Solutions
The projector does not turn on	<ul style="list-style-type: none">• Ensure the power cord is properly attached to the projector and to the power outlet.• If the cooling process has not completed, please wait until it has finished then try to turn on the projector again.• If the above does not work, try another power outlet or another electrical device with the same power outlet.
There is no picture	<ul style="list-style-type: none">• Ensure the video source cable is connected properly, and that the video source is turned on.• If the input source is not selected automatically, select the correct source with the Source key on either the projector or the remote control.
The image is blurred	<ul style="list-style-type: none">• Adjusting focus with the remote control will help correctly focus the projection lens.• Ensure the projector and screen are aligned properly. If necessary, adjust the height of the projector as well as the projection angle and direction.
The remote control does not work	<ul style="list-style-type: none">• Ensure there are no obstacles between the remote control and projector; and that they are within 8 m (26 ft) of each other.• The batteries may be out of power, please check and replace if necessary.

LED Indicators

Light	Status and Description
	
Power	
Red	Stand-by mode (5 sec.) (< 0.5W)
Blue	Power On

Maintenance

General Precautions

- Make sure the projector is turned off and the power cable is unplugged from the power outlet.
- Never remove any parts from the projector. Contact ViewSonic® or a reseller when any part of the projector needs replacing.
- Never spray or pour any liquid directly onto the case.
- Handle the projector with care, as a darker-colored projector, if scuffed, may show marks more clearly than a lighter-colored projector.

Cleaning the Lens

- Use a canister of compressed air to remove dust.
- If the lens is still not clean, use lens-cleaning paper or moisten a soft cloth with lens cleaner and gently wipe the surface.

CAUTION: Never rub the lens with abrasive materials.

Cleaning the Case

- Use a soft, lint-free, dry cloth to remove dirt or dust.
- If the case is still not clean, apply a small amount of non-ammonia, non-alcohol based, mild non-abrasive detergent onto a clean, soft, lint-free cloth, then wipe the surface.

CAUTION: Never use wax, alcohol, benzene, thinner, or other chemical detergents.

Storing the Projector

If you intend to store the projector for an extended period of time:

- Ensure the temperature and humidity of the storage area are within the recommend range.
- Retract the adjuster foot completely.
- Remove the batteries from the remote control.
- Pack the projector in its original packaging or equivalent.

Disclaimer

- ViewSonic® does not recommend the use of any ammonia or alcohol-based cleaners on the lens or case. Some chemical cleaners have been reported to damage the lens and/or case of the projector.
- ViewSonic® will not be liable for damage resulting from use of any ammonia or alcohol-based cleaners.

> Regulatory and Service Information

Compliance Information

This section addresses all connected requirements and statements regarding regulations. Confirmed corresponding applications shall refer to nameplate labels and relevant markings on the unit.

FCC Compliance Statement

This device complies with part 15 of FCC Rules. Operation is subject to the following two conditions: (1) this device may not cause harmful interference, and (2) this device must accept any interference received, including interference that may cause undesired operation. This equipment has been tested and found to comply with the limits for a Class B digital device, pursuant to part 15 of the FCC Rules.

These limits are designed to provide reasonable protection against harmful interference in a residential installation. This equipment generates, uses, and can radiate radio frequency energy, and if not installed and used in accordance with the instructions, may cause harmful interference to radio communications. However, there is no guarantee that interference will not occur in a particular installation. If this equipment does cause harmful interference to radio or television reception, which can be determined by turning the equipment off and on, the user is encouraged to try to correct the interference by one or more of the following measures:

- Reorient or relocate the receiving antenna.
- Increase the separation between the equipment and receiver.
- Connect the equipment into an outlet on a circuit different from that to which the receiver is connected.
- Consult the dealer or an experienced radio/TV technician for help.

Warning: You are cautioned that changes or modifications not expressly approved by the party responsible for compliance could void your authority to operate the equipment.

Industry Canada Statement

CAN ICES-003(B) / NMB-003(B)

This device complies with Industry Canada licence-exempt RSS standard(s).
Operation is subject to the following two conditions:

- (1) This device may not cause interference, and
- (2) This device must accept any interference, including interference that may cause undesired operation of the device.

This device complies with RSS 210 of Industry Canada. This Class B device meets all the requirements of the Canadian interference-causing equipment regulations.

Under Industry Canada regulations, this radio transmitter may only operate using an antenna of a type and maximum (or lesser) gain approved for the transmitter by Industry Canada. To reduce potential radio interference to other users, the antenna type and its gain should be so chosen that the equivalent isotropically radiated power (e.i.r.p.) is not more than that necessary for successful

Antenna Type : Dipole, Gain : 4.35 dBi (2.4 GHz)

CE Conformity for European Countries

 The device complies with the EMC Directive 2014/30/EU and Low Voltage Directive 2014/35/EU.

The following information is only for EU-member states:

The mark shown to the right is in compliance with the Waste Electrical and Electronic Equipment Directive 2012/19/EU (WEEE). The mark indicates the requirement NOT to dispose of the equipment as unsorted municipal waste, but use the return and collection systems according to local law.



Declaration of RoHS2 Compliance

This product has been designed and manufactured in compliance with Directive 2011/65/EU of the European Parliament and the Council on restriction of the use of certain hazardous substances in electrical and electronic equipment (RoHS2 Directive) and is deemed to comply with the maximum concentration values issued by the European Technical Adaptation Committee (TAC) as shown below:

Substance	Proposed Maximum Concentration	Actual Concentration
Lead (Pb)	0.1%	< 0.1%
Mercury (Hg)	0.1%	< 0.1%
Cadmium (Cd)	0.01%	< 0.01%
Hexavalent Chromium (Cr6 ⁺)	0.1%	< 0.1%
Polybrominated biphenyls (PBB)	0.1%	< 0.1%
Polybrominated diphenyl ethers (PBDE)	0.1%	< 0.1%

Certain components of products as stated above are exempted under the Annex III of the RoHS2 Directives as noted below. Examples of exempted components are:

- Mercury in cold cathode fluorescent lamps and external electrode fluorescent lamps (CCFL and EEFL) for special purposes not exceeding (per lamp):
 - » Short length (500 mm): maximum 3.5 mg per lamp.
 - » Medium length (> 500 mm and 1,500 mm): maximum 5 mg per lamp.
 - » Long length (> 1,500 mm): maximum 13 mg per lamp.
- Lead in glass of cathode ray tubes.
- Lead in glass of fluorescent tubes not exceeding 0.2% by weight.
- Lead as an alloying element in aluminum containing up to 0.4% lead by weight.
- Copper alloy containing up to 4% lead by weight.
- Lead in high melting temperature type solders (i.e. lead-based alloys containing 85% by weight or more lead).
- Electrical and electronic components containing lead in a glass or ceramic other than dielectric ceramic in capacitors, e.g. piezoelectronic devices, or in a glass or ceramic matrix compound.

Indian Restriction of Hazardous Substances

Restriction on Hazardous Substances statement (India). This product complies with the “India E-waste Rule 2011” and prohibits use of lead, mercury, hexavalent chromium, polybrominated biphenyls or polybrominated diphenyl ethers in concentrations exceeding 0.1 weight % and 0.01 weight % for cadmium, except for the exemptions set in Schedule 2 of the Rule.

Product Disposal at End of Product Life

ViewSonic® respects the environment and is committed to working and living green. Thank you for being part of Smarter, Greener Computing. Please visit the ViewSonic® website to learn more.

USA & Canada:

<http://www.viewsonic.com/company/green/recycle-program/>

Europe:

<http://www.viewsoniceurope.com/eu/support/call-desk/>

Taiwan:

<https://recycle.epa.gov.tw/>

Copyright Information

Copyright© ViewSonic® Corporation, 2021. All rights reserved.

Macintosh and Power Macintosh are registered trademarks of Apple Inc.

Microsoft, Windows, and the Windows logo are registered trademarks of Microsoft Corporation in the United States and other countries.

ViewSonic®, the three birds logo, OnView, ViewMatch, and ViewMeter are registered trademarks of ViewSonic® Corporation.

VESA is a registered trademark of the Video Electronics Standards Association. DPMS, DisplayPort, and DDC are trademarks of VESA.

ENERGY STAR® is a registered trademark of the U.S. Environmental Protection Agency (EPA).

As an ENERGY STAR® partner, ViewSonic® Corporation has determined that this product meets the ENERGY STAR® guidelines for energy efficiency.

Disclaimer: ViewSonic® Corporation shall not be liable for technical or editorial errors or omissions contained herein; nor for incidental or consequential damages resulting from furnishing this material, or the performance or use of this product.

In the interest of continuing product improvement, ViewSonic® Corporation reserves the right to change product specifications without notice. Information in this document may change without notice.

No part of this document may be copied, reproduced, or transmitted by any means, for any purpose without prior written permission from ViewSonic® Corporation.

Customer Service

For technical support or product service, see the table below or contact your reseller.

NOTE: You will need the product's serial number.

Country/ Region	Website	Country/ Region	Website
Asia Pacific & Africa			
Australia	www.viewsonic.com/au/	Bangladesh	www.viewsonic.com/bd/
中国 (China)	www.viewsonic.com.cn	香港 (繁體中文)	www.viewsonic.com/hk/
Hong Kong (English)	www.viewsonic.com/hk-en/	India	www.viewsonic.com/in/
Indonesia	www.viewsonic.com/id/	Israel	www.viewsonic.com/il/
日本 (Japan)	www.viewsonic.com/jp/	Korea	www.viewsonic.com/kr/
Malaysia	www.viewsonic.com/my/	Middle East	www.viewsonic.com/me/
Myanmar	www.viewsonic.com/mm/	Nepal	www.viewsonic.com/np/
New Zealand	www.viewsonic.com/nz/	Pakistan	www.viewsonic.com/pk/
Philippines	www.viewsonic.com/ph/	Singapore	www.viewsonic.com/sg/
臺灣 (Taiwan)	www.viewsonic.com/tw/	ประเทศไทย	www.viewsonic.com/th/
Việt Nam	www.viewsonic.com/vn/	South Africa & Mauritius	www.viewsonic.com/za/
Americas			
United States	www.viewsonic.com/us	Canada	www.viewsonic.com/us
Latin America	www.viewsonic.com/la		
Europe			
Europe	www.viewsonic.com/eu/	France	www.viewsonic.com/fr/
Deutschland	www.viewsonic.com/de/	Қазақстан	www.viewsonic.com/kz/
Россия	www.viewsonic.com/ru/	España	www.viewsonic.com/es/
Türkiye	www.viewsonic.com/tr/	Україна	www.viewsonic.com/ua/
United Kingdom	www.viewsonic.com/uk/		

Limited Warranty

ViewSonic® Projector

What the warranty covers:

ViewSonic® warrants its products to be free from defects in material and workmanship, under normal use, during the warranty period. If a product proves to be defective in material or workmanship during the warranty period, ViewSonic® will, at its sole option, repair or replace the product with a like product. Replacement product or parts may include remanufactured or refurbished parts or components.

Limited Three (3) year General Warranty:

Subject to the more limited one (1) year warranty set out below, North and South America: Three (3) years warranty for all parts excluding the lamp, three (3) years for labor, and one (1) year for the original lamp from the date of the first consumer purchase.

Other regions or countries: Please check with your local dealer or local ViewSonic® office for the warranty information.

Limited One (1) year Heavy Usage Warranty:

Under heavy usage settings, where a projector's use includes more than fourteen (14) hours average daily usage, North and South America: One (1) year warranty for all parts excluding the lamp, one (1) year for labor, and ninety (90) days for the original lamp from the date of the first consumer purchase; Europe: One (1) year warranty for all parts excluding the lamp, one (1) year for labor, and ninety (90) days for the original lamp from the date of the first consumer purchase. Other regions or countries: Please check with your local dealer or local ViewSonic® office for the warranty information. Lamp warranty subject to terms and conditions, verification and approval. Applies to manufacturer's installed lamp only. All accessory lamps purchased separately are warranted for 90 days.

Who the warranty protects:

This warranty is valid only for the first consumer purchaser.

What the warranty does not cover:

1. Any product on which the serial number has been defaced, modified, or removed.
2. Damage, deterioration, or malfunction resulting from:
 - » Accident, misuse, neglect, fire, water, lightning, or other acts of nature, unauthorized product modification, or failure to follow instructions supplied with the product.
 - » Operation outside of product specifications.
 - » Operation of the product for other than the normal intended use or not under normal conditions.
 - » Repair or attempted repair by anyone not authorized by ViewSonic®.
 - » Any damage of the product due to shipment.
 - » Removal or installation of the product.
 - » Causes external to the product, such as electric power fluctuations or failure.
 - » Use of supplies or parts not meeting Viewsonic's specifications.
 - » Normal wear and tear.
 - » Any other cause which does not relate to a product defect.
3. Removal, installation, and set-up service charges.

How to get service:

1. For information about receiving service under warranty, contact ViewSonic® Customer Support (Please refer to the "Customer Support" page). You will need to provide your product's serial number.
2. To obtain warranted service, you will be required to provide: (a) the original dated sales slip, (b) your name, (c) your address, (d) a description of the problem, and (e) the serial number of the product.
3. Take or ship the product, freight prepaid, in the original container to an authorized ViewSonic® service center or ViewSonic®.
4. For additional information or the name of the nearest ViewSonic® service center, contact ViewSonic®.

Limitation of implied warranties:

There are no warranties, express or implied, which extend beyond the description contained herein including the implied warranty of merchantability and fitness for a particular purpose.

Exclusion of damages:

ViewSonic's liability is limited to the cost of repair or replacement of the product. ViewSonic® shall not be liable for:

1. Damage to other property caused by any defects in the product, damages based upon inconvenience, loss of use of the product, loss of time, loss of profits, loss of business opportunity, loss of goodwill, interference with business relationships, or other commercial loss, even if advised of the possibility of such damages.
2. Any other damages, whether incidental, consequential or otherwise.
3. Any claim against the customer by any other party.

Effect of state law:

This warranty gives you specific legal rights, and you may also have other rights which vary from local authority. Some local governments do not allow limitations on implied warranties and/or do not allow the exclusion of incidental or consequential damages, so the above limitations and exclusions may not apply to you.

Sales outside the U.S.A. and Canada:

For warranty information and service on ViewSonic® products sold outside of the U.S.A. and Canada, contact ViewSonic® or your local ViewSonic® dealer.

The warranty period for this product in mainland China (Hong Kong, Macao, and Taiwan Excluded) is subject to the terms and conditions of the Maintenance Guarantee Card.

For users in Europe and Russia, full details of warranty provided can be found at: <http://www.viewsonic.com/eu/> under "Support/Warranty Information".

Mexico Limited Warranty

ViewSonic® Projector

What the warranty covers:

ViewSonic® warrants its products to be free from defects in material and workmanship, under normal use, during the warranty period. If a product proves to be defective in material or workmanship during the warranty period, ViewSonic® will, at its sole option, repair or replace the product with a like product. Replacement product or parts may include remanufactured or refurbished parts or components & accessories.

How long the warranty is effective:

3 years for all parts excluding the lamp, 3 years for labor, 1 year for the original lamp from the date of the first consumer purchase.

Lamp warranty subject to terms and conditions, verification and approval. Applies to manufacturer's installed lamp only.

All accessory lamps purchased separately are warranted for 90 days.

Who the warranty protects:

This warranty is valid only for the first consumer purchaser.

What the warranty excludes and does not cover:

1. Any product on which the serial number has been defaced, modified or removed.
2. Damage, deterioration, or malfunction resulting from:
 - » Accident, misuse, neglect, fire, water, lightning, or other acts of nature, unauthorized product modification, unauthorized attempted repair, or failure to follow instructions supplied with the product.
 - » Any damage of the product due to shipment.
 - » Causes external to the product, such as electrical power fluctuations or failure.
 - » Use of supplies or parts not meeting ViewSonic®'s specifications.
 - » Normal wear and tear.
 - » Any other cause which does not relate to a product defect.
3. Any product exhibiting a condition commonly known as "image burn-in" which results when a static image is displayed on the product for an extended period of time.
4. Removal, installation, insurance, and set-up service charges.

How to get service:

For information about receiving service under warranty, contact ViewSonic® Customer Support (Please refer to the attached “Customer Service” page). You will need to provide your product’s serial number, so please record the product information in the space provided below on your purchase for your future use. Please retain your receipt of proof of purchase to support your warranty claim.

For Your Records

Product Name: _____ Model Number: _____

Document Number: _____ Serial Number: _____

Purchase Date: _____ Extended Warranty Purchase? _____ (Y/N)

If so, what date does warranty expire? _____

1. To obtain warranty service, you will be required to provide (a) the original dated sales slip, (b) your name, (c) your address, (d) a description of the problem, and (e) the serial number of the product.
2. Take or ship the product, in the original container packaging, to an authorized ViewSonic® service center.
3. Round trip transportation costs for in-warranty products will be paid by ViewSonic®.

Limitation of implied warranties:

There are no warranties, express or implied, which extend beyond the description contained herein including the implied warranty of merchantability and fitness for a particular purpose.

Exclusion of damages:

ViewSonic®’s liability is limited to the cost of repair or replacement of the product. ViewSonic® shall not be liable for:

1. Damage to other property caused by any defects in the product, damages based upon inconvenience, loss of use of the product, loss of time, loss of profits, loss of business opportunity, loss of goodwill, interference with business relationships, or other commercial loss, even if advised of the possibility of such damages.
2. Any other damages, whether incidental, consequential or otherwise.
3. Any claim against the customer by any other party.
4. Repair or attempted repair by anyone not authorized by ViewSonic®.

Contact Information for Sales & Authorized Service (Centro Autorizado de Servicio) within Mexico:	
Name, address, of manufacturer and importers: México, Av. de la Palma #8 Piso 2 Despacho 203, Corporativo Interpalmas, Col. San Fernando Huixquilucan, Estado de México Tel: (55) 3605-1099 http://www.viewsonic.com/la/soporte/index.htm	
NÚMERO GRATIS DE ASISTENCIA TÉCNICA PARA TODO MÉXICO: 001.866.823.2004	
Hermosillo: Distribuciones y Servicios Computacionales SA de CV. Calle Juárez 284 local 2 Col. Bugambilias C.P: 83140 Tel: 01-66-22-14-9005 E-Mail: disc2@hmo.megared.net.mx	Villahermosa: Compumantenimientos Garantizados, S.A. de C.V. AV. GREGORIO MENDEZ #1504 COL, FLORIDA C.P. 86040 Tel: 01 (993) 3 52 00 47 / 3522074 / 3 52 20 09 E-Mail: compumantenimientos@prodigy.net.mx
Puebla, Pue. (Matriz): RENTA Y DATOS, S.A. DE C.V. Domicilio: 29 SUR 721 COL. LA PAZ 72160 PUEBLA, PUE. Tel: 01(52).222.891.55.77 CON 10 LINEAS E-Mail: datos@puebla.megared.net.mx	Veracruz, Ver.: CONEXION Y DESARROLLO, S.A DE C.V. Av. Americas # 419 ENTRE PINZÓN Y ALVARADO Fracc. Reforma C.P. 91919 Tel: 01-22-91-00-31-67 E-Mail: gacosta@qplus.com.mx
Chihuahua: Soluciones Globales en Computación C. Magisterio # 3321 Col. Magisterial Chihuahua, Chih. Tel: 4136954 E-Mail: Cefeo@soluglobales.com	Cuernavaca: Compusupport de Cuernavaca SA de CV Francisco Leyva # 178 Col. Miguel Hidalgo C.P. 62040, Cuernavaca Morelos Tel: 01 777 3180579 / 01 777 3124014 E-Mail: aquevedo@compusupportcva.com
Distrito Federal: QPLUS, S.A. de C.V. Av. Coyoacán 931 Col. Del Valle 03100, México, D.F. Tel: 01(52)55-50-00-27-35 E-Mail : gacosta@qplus.com.mx	Guadalajara, Jal.: SERVICRECE, S.A. de C.V. Av. Niños Héroes # 2281 Col. Arcos Sur, Sector Juárez 44170, Guadalajara, Jalisco Tel: 01(52)33-36-15-15-43 E-Mail: mmiranda@servicrece.com
Guerrero Acapulco: GS Computación (Grupo Sesicomp) Progreso #6-A, Colo Centro 39300 Acapulco, Guerrero Tel: 744-48-32627	Monterrey: Global Product Services Mar Caribe # 1987, Esquina con Golfo Pérsico Fracc. Bernardo Reyes, CP 64280 Monterrey N.L. México Tel: 8129-5103 E-Mail: aydeem@gps1.com.mx
MERIDA: ELECTROSER Av Reforma No. 403Gx39 y 41 Mérida, Yucatán, México CP97000 Tel: (52) 999-925-1916 E-Mail: rrrb@sureste.com	Oaxaca, Oax.: CENTRO DE DISTRIBUCION Y SERVICIO, S.A. de C.V. Murguía # 708 P.A., Col. Centro, 68000, Oaxaca Tel: 01(52)95-15-15-22-22 Fax: 01(52)95-15-13-67-00 E-Mail: gpotai2001@hotmail.com
Tijuana: STD Av Ferrocarril Sonora #3780 L-C Col 20 de Noviembre Tijuana, Mexico	FOR USA SUPPORT: ViewSonic® Corporation 381 Brea Canyon Road, Walnut, CA. 91789 USA Tel: 800-688-6688 E-Mail: http://www.viewsonic.com



ViewSonic®
See the difference®